

# COMBINED TYPE NEEDLE ROLLER BEARINGS

- Needle Roller Bearings with Thrust Ball Bearing
- Needle Roller Bearings with Thrust Roller Bearing
- Needle Roller Bearings with Angular Contact Ball Bearing
- Needle Roller Bearings with Three-point Contact Ball Bearing



## Structure and Features

IKO Combined Type Needle Roller Bearings are combinations of a radial bearing and a thrust bearing. Caged needle roller bearings are used as radial bearings and thrust ball bearings or thrust roller bearings are used as thrust bearings. They are compact and very economical, and can be subjected to radial loads and axial loads simultaneously. They are widely used for machine tools, textile machinery, and industrial machinery.

## Types

The types of Combined Type Needle Roller Bearings shown in Table 1 are available.

Table 1.1 Type of bearing

Type	Combined with thrust ball bearing		Combined with thrust roller bearing	
	Without inner ring	With inner ring	Without inner ring	With inner ring
—	NAX	NAXI	NBX	NBXI
With dust cover	NAX ... Z	NAXI ... Z	NBX ... Z	NBXI ... Z

Table 1.2 Type of bearing

Type	Combined with angular contact ball bearing	Combined with three-point contact ball bearing
Model code	NATA	NATB

## Needle Roller Bearings with Thrust Ball Bearing

In this series, needle roller bearings are combined with thrust ball bearings to receive thrust loads. In bearings with a dust cover, the dust cover is formed from a thin steel plate and fixed to a groove cut on the outer cylindrical surface of the outer ring collar. The cover forms a labyrinth with the thrust raceway ring, and is therefore effective in preventing leakage of grease and penetration of dust and dirt. In the case of bearings without an inner ring, the tolerances of roller set bore diameter  $F_w$  are shown in Table 14 on page A33. Therefore, the required radial internal clearances can be selected by combining the bearings with shafts that have been heat-treated and finished by grinding as shown in Table 23 on page A42 and Table 26 on page A44.

### Structures of Combined Type Needle Roller Bearings

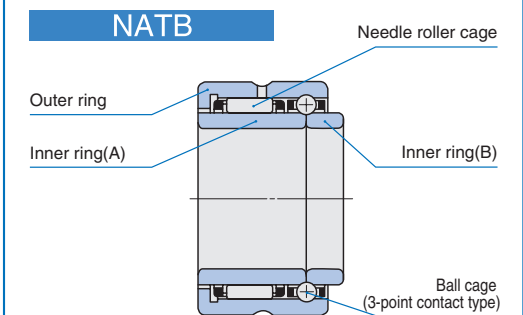
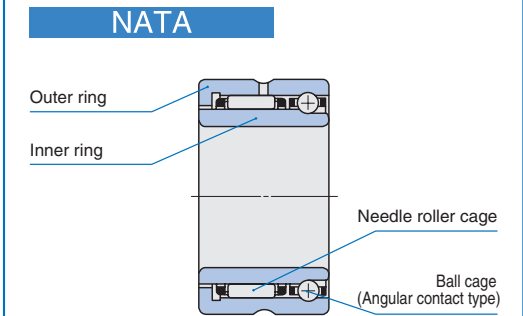
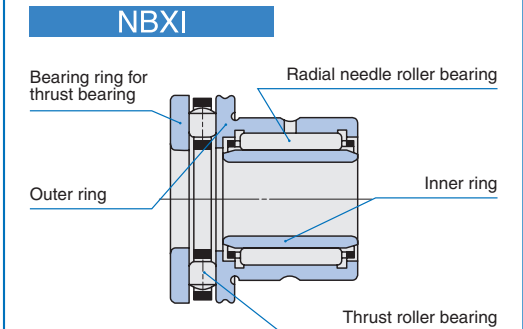
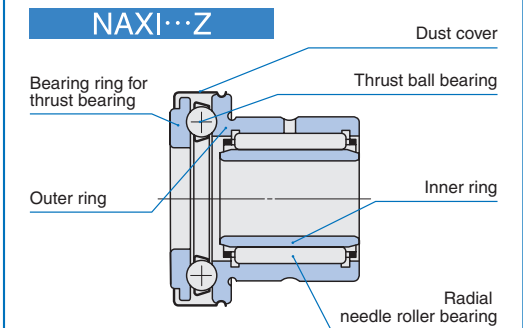

### Needle Roller Bearings with Thrust Roller Bearing

In this series, needle roller bearings are combined with thrust roller bearings to receive thrust loads. Their axial load ratings are greater than those of bearings that are combined with thrust ball bearings. Also, elastic deformation of the rolling contact surfaces under load is minimal. Furthermore, the thrust bearing section is finished to high accuracy, and therefore high rotational accuracy is obtained in the case of both vertical and horizontal shafts. Like the needle roller bearings with thrust ball bearing, this series also includes bearings with a dust cover and bearings with an inner ring.

### Needle Roller Bearings with Angular Contact Ball Bearing

In this series, caged needle roller bearings are combined with angular contact ball bearings to receive thrust loads. These bearings conform to the international dimension series #59, which is based on the ISO Standard. They can withstand heavy radial loads and unidirectional axial loads simultaneously. When the axial load exceeds 25% of the radial load, the radial load will be induced in the angular contact ball bearing, and bearing life will be affected. The relationship between the two loads must therefore be taken into careful consideration.

### Needle Roller Bearings with Three-point Contact Ball Bearing

These bearings can withstand heavy radial loads and bi-directional axial loads at the same time during high-speed rotation. Since the non-interchangeable inner rings are separated at the center of the ball raceway surface, they must be firmly tightened against the shaft in the axial direction. The axial clearance of this bearing is 0.1 ~ 0.3 mm, and like NATA59, the axial load should not exceed 25% of the radial load.

## Identification Number

The identification number of Combined Type Needle Roller Bearings consists of a model code, dimensions, any supplemental codes and a classification symbol. Some examples are shown below.

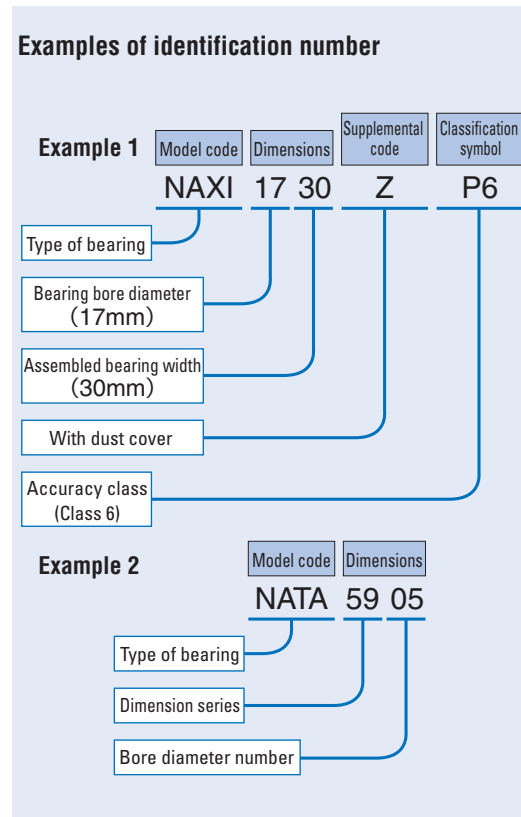

## Accuracy

Dimensional accuracy and rotational accuracy of Combined Type Needle Roller Bearings are based on Table 2 below and Tables 12 and 13 on page A31. The tolerances for the smallest single roller set bore diameter of bearings without inner ring are based on Table 14 on page A33. Thickness variations of thrust rings of NAX(I) and NBX(I) are based on Table 2.4 on page F5. Bore diameter of the small width inner ring of NATB59 is made for a transition fit with k5 tolerance shaft.

Table 2 Tolerances unit: mm

Type of bearing	Item	Dimension	Dimension symbol	Tolerance
NAX(I) <sup>(1)</sup> NBX(I) <sup>(1)</sup>	Bore dia. of bearing ring for thrust bearing		$d_i$	E7
	Assembled bearing width		$L$	0 - 0.25
	Bearing height of thrust bearing		$H$	0 - 0.20
NATB59	Width of inner ring		$B$	0 - 0.3

Note<sup>(1)</sup> Also applicable to bearings with dust cover

## Clearance

Combined Type Needle Roller Bearings are manufactured to have the radial internal clearance CN shown in Table 18 on page A37.

## Fit

The recommended fits for Combined Type Needle Roller Bearings are shown in Table 3.

Table 3 Recommended fits

Type of bearing	Item	Tolerance class		
		Shaft		Housing bore
		Without inner ring	With inner ring	
NAX(I) <sup>(1)</sup> NBX(I) <sup>(1)</sup>		h5, k5	k5	K6, M6
NATA59 NATB59		—	k5 <sup>(2)</sup>	M6 <sup>(2)</sup>

Notes<sup>(1)</sup> The housing bore for the thrust bearing must be machined to be more than 0.5 mm larger than the outside diameters  $D_1$  and  $D_2$  to ensure that it does not incur radial loads.

<sup>(2)</sup> If the fit is made tighter than specified in this table, radial loads will act upon the thrust bearing, limiting its function.

## Lubrication

Grease is not prepacked in Combined Type Needle Roller Bearings, so perform proper lubrication for use. Operating without lubrication will increase the wear of the rolling contact surfaces and shorten the bearing life.

## Oil Hole

The outer ring of Combined Type Needle Roller Bearings has an oil groove and an oil hole. When outer rings with multiple oil holes or inner rings with oil hole(s) are required, please contact IKO.

## Rating Life

In Combined Type Needle Roller Bearings, caged needle roller bearings are subjected to radial loads while thrust bearings receive axial loads. Therefore, it is necessary to calculate their lives respectively (page A17).

## Mounting

Fig.1 shows mounting examples of Combined Type Needle Roller Bearings. When applying preload to the NAX and NBX models, it is recommended that thrust raceway rings are not tightened directly with nuts, but are tightened using springs as shown in Fig. 2. Mounting two NATA models symmetrically allows them to be subjected to two-way axial loads. When mounting these models, an axial clearance of 0.2 ~ 0.3 mm should be provided in the angular contact ball bearings so that radial loads are not applied to the angular contact ball bearings. Dimensions related to mounting should be based on the table of dimensions.

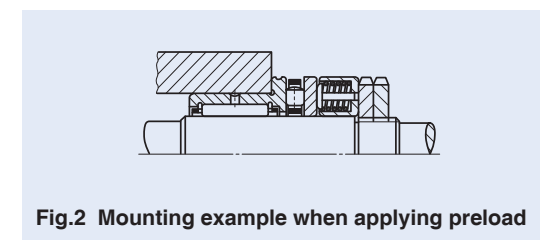
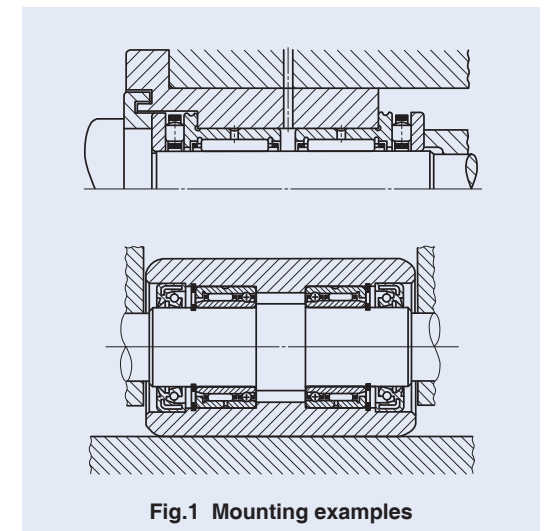

G  
NAX  
NBX  
NATA  
NATB

COMBINED TYPE NEEDLE ROLLER BEARINGS

Needle Roller Bearings with Thrust Ball Bearing  
Needle Roller Bearings with Thrust Roller Bearing

Without Inner Ring  
Without Inner Ring

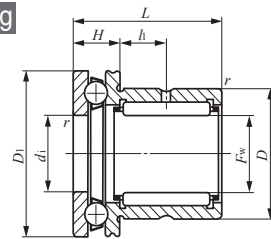

NAX

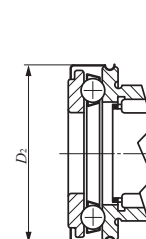

NAX...Z

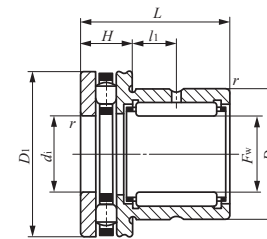

NBX

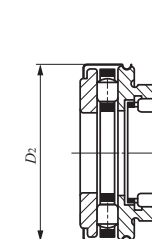

NBX...Z

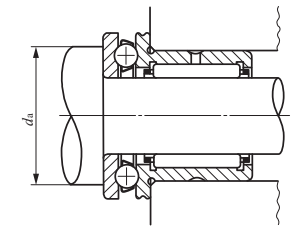

Shaft dia. 10 – 70mm

Shaft dia. mm	Identification number							
	Mass (Ref.) g	With dust cover	Mass (Ref.) g	Mass (Ref.) g	With dust cover	Mass (Ref.) g	With dust cover	Mass (Ref.) g
10	NAX 1023	38.5	NAX 1023Z	40	—	—	—	—
12	NAX 1223	43.5	NAX 1223Z	45.5	—	—	—	—
15	NAX 1523	47.5	NAX 1523Z	48.5	—	—	—	—
	—	—	—	—	NBX 1523	54	NBX 1523Z	55
17	NAX 1725	54	NAX 1725Z	56	—	—	—	—
	—	—	—	—	NBX 1725	61	NBX 1725Z	63
20	NAX 2030	85.5	NAX 2030Z	89	—	—	—	—
	—	—	—	—	NBX 2030	94	NBX 2030Z	97.5
25	NAX 2530	131	NAX 2530Z	135	—	—	—	—
	—	—	—	—	NBX 2530	143	NBX 2530Z	147
30	NAX 3030	145	NAX 3030Z	151	—	—	—	—
	—	—	—	—	NBX 3030	160	NBX 3030Z	166
35	NAX 3530	169	NAX 3530Z	176	—	—	—	—
	—	—	—	—	NBX 3530	186	NBX 3530Z	193
40	NAX 4032	219	NAX 4032Z	227	—	—	—	—
	—	—	—	—	NBX 4032	240	NBX 4032Z	248
45	NAX 4532	264	NAX 4532Z	273	—	—	—	—
	—	—	—	—	NBX 4532	293	NBX 4532Z	302
50	NAX 5035	287	NAX 5035Z	297	—	—	—	—
	—	—	—	—	NBX 5035	315	NBX 5035Z	325
60	NAX 6040	417	NAX 6040Z	454	—	—	—	—
	—	—	—	—	NBX 6040	501	NBX 6040Z	538
70	NAX 7040	555	NAX 7040Z	606	—	—	—	—

Notes<sup>(1)</sup> Minimum allowable value of chamfer dimension *r*  
<sup>(2)</sup> Allowable rotational speed applies to oil lubrication. For grease lubrication, a maximum of 70% of this value is allowable in the NAX series, and a maximum of 25% of this value is allowable in the NBX series.  
 Remarks1. The outer ring has an oil groove and an oil hole.  
 2. No grease is prepacked. Perform proper lubrication.

F <sub>w</sub>	Boundary dimensions mm									Standard mounting dimension <i>d<sub>a</sub></i> Min. mm	Basic dynamic load rating <i>C</i>		Basic static load rating <i>C<sub>0</sub></i>		Allowable rotational speed <sup>(2)</sup> min <sup>-1</sup>
	<i>D</i>	<i>D</i> <sub>1</sub>	<i>D</i> <sub>2</sub>	<i>L</i>	<i>H</i>	<i>l</i> <sub>1</sub>	<i>r<sub>s</sub></i> min <sup>(1)</sup>	<i>d<sub>i</sub></i>	Radial N		Axial N	Radial N	Axial N		
10	19	24	25	23	9	6.5	0.3	10	18	8 230	10 000	9 190	11 100	9 500	
12	21	26	27	23	9	6.5	0.3	12	20	9 250	9 670	11 200	11 100	9 000	
15	24	28	29	23	9	6.5	0.3	15	23	12 300	9 930	14 900	12 200	8 500	
15	24	28	29	23	9	6.5	0.3	15	26	12 300	10 200	14 900	23 900	14 000	
17	26	30	31	25	9	8	0.3	17	25	12 900	10 800	16 300	14 500	8 500	
17	26	30	31	25	9	8	0.3	17	28	12 900	11 400	16 300	28 600	13 000	
20	30	35	36	30	10	10.5	0.3	20	29	17 600	14 200	25 400	19 700	7 500	
20	30	35	36	30	10	10.5	0.3	20	33	17 600	19 000	25 400	48 700	11 000	
25	37	42	43	30	11	9.5	0.6	25	35	20 000	19 600	32 100	29 700	7 000	
25	37	42	43	30	11	9.5	0.6	25	40	20 000	22 700	32 100	60 700	9 000	
30	42	47	48	30	11	9.5	0.6	30	40	25 100	20 400	40 100	33 600	6 500	
30	42	47	48	30	11	9.5	0.6	30	45	25 100	27 400	40 100	81 000	8 000	
35	47	52	53	30	12	9	0.6	35	45	26 900	21 200	46 200	37 600	6 000	
35	47	52	53	30	12	9	0.6	35	50	26 900	29 100	46 200	91 100	7 000	
40	52	60	61	32	13	10	0.6	40	52	29 400	26 900	54 100	50 000	5 500	
40	52	60	61	32	13	10	0.6	40	57	29 400	41 700	54 100	133 000	6 000	
45	58	65	66.5	32	14	9	0.6	45	57	31 000	27 900	60 200	55 100	5 000	
45	58	65	66.5	32	14	9	0.6	45	62	31 000	40 800	60 200	133 000	5 500	
50	62	70	71.5	35	14	10	0.6	50	62	42 200	28 800	83 400	60 100	4 500	
50	62	70	71.5	35	14	10	0.6	50	67	42 200	43 300	83 400	148 000	5 000	
60	72	85	86.5	40	17	12	1	60	75	47 500	41 400	103 000	89 700	4 000	
60	72	85	86.5	40	17	12	1	60	82	47 500	64 600	103 000	224 000	4 000	
70	85	95	96.5	40	18	11	1	70	85	55 500	43 100	120 000	101 000	3 500	

G

NAX  
NBX  
NATA  
NATB

COMBINED TYPE NEEDLE ROLLER BEARINGS

Needle Roller Bearings with Thrust Ball Bearing  
Needle Roller Bearings with Thrust Roller Bearing

With Inner Ring  
With Inner Ring

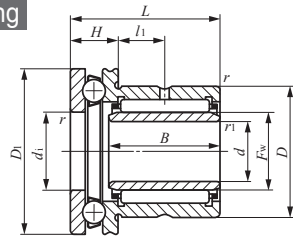

NAXI

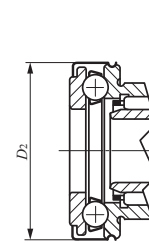

NAXI ... Z

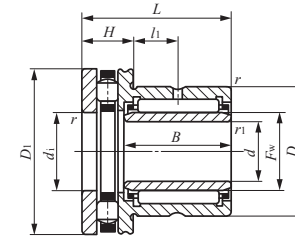

NBXI

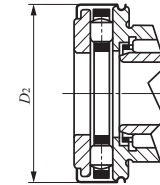

NBXI ... Z

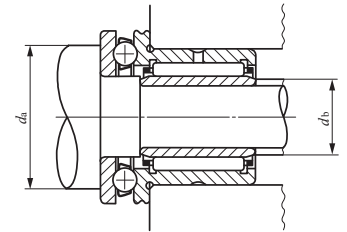

Shaft dia. 7 – 60mm

Shaft dia. mm	Identification number								d	D	D <sub>1</sub>
	Mass (Ref.) g	With dust cover	Mass (Ref.) g	With dust cover	Mass (Ref.) g	With dust cover	Mass (Ref.) g	With dust cover			
7	NAXI 723	43.5	NAXI 723Z	45	—	—	—	—	7	19	24
9	NAXI 923	49.5	NAXI 923Z	51.5	—	—	—	—	9	21	26
12	NAXI 1223	55.5	NAXI 1223Z	56.5	—	—	—	—	12	24	28
					NBXI 1223	62	NBXI 1223Z	63	12	24	28
14	NAXI 1425	63.5	NAXI 1425Z	65.5	—	—	—	—	14	26	30
					NBXI 1425	70.5	NBXI 1425Z	72.5	14	26	30
17	NAXI 1730	99	NAXI 1730Z	103	—	—	—	—	17	30	35
					NBXI 1730	108	NBXI 1730Z	111	17	30	35
20	NAXI 2030	159	NAXI 2030Z	163	—	—	—	—	20	37	42
					NBXI 2030	171	NBXI 2030Z	175	20	37	42
25	NAXI 2530	179	NAXI 2530Z	185	—	—	—	—	25	42	47
					NBXI 2530	194	NBXI 2530Z	200	25	42	47
30	NAXI 3030	208	NAXI 3030Z	215	—	—	—	—	30	47	52
					NBXI 3030	225	NBXI 3030Z	232	30	47	52
35	NAXI 3532	265	NAXI 3532Z	273	—	—	—	—	35	52	60
					NBXI 3532	286	NBXI 3532Z	294	35	52	60
40	NAXI 4032	315	NAXI 4032Z	324	—	—	—	—	40	58	65
					NBXI 4032	344	NBXI 4032Z	353	40	58	65
45	NAXI 4535	358	NAXI 4535Z	368	—	—	—	—	45	62	70
					NBXI 4535	386	NBXI 4535Z	396	45	62	70
50	NAXI 5040	582	NAXI 5040Z	619	—	—	—	—	50	72	85
					NBXI 5040	666	NBXI 5040Z	703	50	72	85
60	NAXI 6040	750	NAXI 6040Z	801	—	—	—	—	60	85	95

Notes<sup>(1)</sup> Minimum allowable value of chamfer dimension  $r$  or  $r_1$   
<sup>(2)</sup> Allowable rotational speed applies to oil lubrication. For grease lubrication, a maximum of 70% of this value is allowable in the NAXI series, and a maximum of 25% of this value is allowable in the NBXI series.  
 Remarks1. The outer ring has an oil groove and an oil hole.  
 2. No grease is prepacked. Perform proper lubrication.

Boundary dimensions mm											Standard mounting dimensions mm		Basic dynamic load rating C		Basic static load rating C <sub>0</sub>		Allowable rotational speed <sup>(2)</sup> min <sup>-1</sup>	Assembled inner ring
D <sub>2</sub>	L	B	H	l <sub>1</sub>	r <sub>s min</sub> <sup>(1)</sup>	r <sub>ls min</sub> <sup>(1)</sup>	F <sub>w</sub>	d <sub>i</sub>	d <sub>a</sub> Min.	d <sub>b</sub>	Radial N	Axial N	Radial N	Axial N				
25	23	16	9	6.5	0.3	0.2	10	10	18	9	8 230	10 000	9 190	11 100	9 500	LRT 71016		
27	23	16	9	6.5	0.3	0.3	12	12	20	11	9 250	9 670	11 200	11 100	9 000	LRT 91216		
29	23	16.5	9	6.5	0.3	0.3	15	15	23	14	12 300	9 930	14 900	12 200	8 500	LRT 121516		
29	23	16.5	9	6.5	0.3	0.3	15	15	26	14	12 300	10 200	14 900	23 900	14 000	LRT 121516		
31	25	17	9	8	0.3	0.3	17	17	25	16	12 900	10 800	16 300	14 500	8 500	LRT 141717		
31	25	17	9	8	0.3	0.3	17	17	28	16	12 900	11 400	16 300	28 600	13 000	LRT 141717		
36	30	20.5	10	10.5	0.3	0.3	20	20	29	19	17 600	14 200	25 400	19 700	7 500	LRT 172020		
36	30	20.5	10	10.5	0.3	0.3	20	20	33	19	17 600	19 000	25 400	48 700	11 000	LRT 172020		
43	30	20.5	11	9.5	0.6	0.3	25	25	35	24	20 000	19 600	32 100	29 700	7 000	LRT 202520		
43	30	20.5	11	9.5	0.6	0.3	25	25	40	24	20 000	22 700	32 100	60 700	9 000	LRT 202520		
48	30	20.5	11	9.5	0.6	0.3	30	30	40	29	25 100	20 400	40 100	33 600	6 500	LRT 253020		
48	30	20.5	11	9.5	0.6	0.3	30	30	45	29	25 100	27 400	40 100	81 000	8 000	LRT 253020		
53	30	20	12	9	0.6	0.3	35	35	45	34	26 900	21 200	46 200	37 600	6 000	LRT 303520		
53	30	20	12	9	0.6	0.3	35	35	50	34	26 900	29 100	46 200	91 100	7 000	LRT 303520		
61	32	20	13	10	0.6	0.3	40	40	52	39	29 400	26 900	54 100	50 000	5 500	LRT 354020		
61	32	20	13	10	0.6	0.3	40	40	57	39	29 400	41 700	54 100	133 000	6 000	LRT 354020		
66.5	32	20	14	9	0.6	0.3	45	45	57	44	31 000	27 900	60 200	55 100	5 000	LRT 404520		
66.5	32	20	14	9	0.6	0.3	45	45	62	44	31 000	40 800	60 200	133 000	5 500	LRT 404520		
71.5	35	25	14	10	0.6	0.3	50	50	62	49	42 200	28 800	83 400	60 100	4 500	LRT 455025		
71.5	35	25	14	10	0.6	0.3	50	50	67	49	42 200	43 300	83 400	148 000	5 000	LRT 455025		
86.5	40	25.5	17	12	1	1	60	60	75	59	47 500	41 400	103 000	89 700	4 000	LRT 506025		
86.5	40	25.5	17	12	1	1	60	60	82	59	47 500	64 600	103 000	224 000	4 000	LRT 506025		
96.5	40	25.5	18	11	1	1	70	70	85	68	55 500	43 100	120 000	101 000	3 500	LRT 607025		

**COMBINED TYPE NEEDLE ROLLER BEARINGS**

Needle Roller Bearings with Angular Contact Ball Bearing  
 Needle Roller Bearings with Three-point Contact Ball Bearing

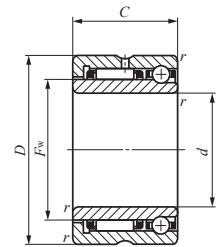

NATA59

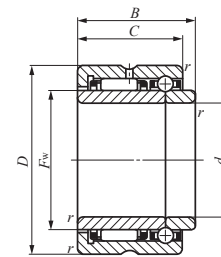

NATB59

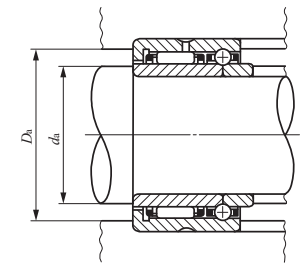
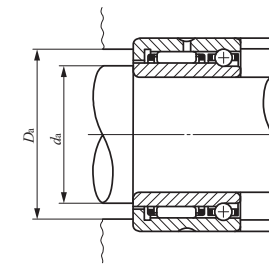

Shaft dia. 15 – 70mm

Shaft dia. mm	Identification number				Boundary dimensions mm						
	Angular contact type	Mass (Ref.) g	Three-point contact type	Mass (Ref.) g	d	D	C	B	$r_{s\ min}^{(1)}$	$F_w$	
15	NATA 5902	50.5	NATB 5902	53	15	28	18	20	0.3	20	
17	NATA 5903	55.5	NATB 5903	58.5	17	30	18	20	0.3	22	
20	NATA 5904	111	NATB 5904	115	20	37	23	25	0.3	25	
25	NATA 5905	131	NATB 5905	136	25	42	23	25	0.3	30	
30	NATA 5906	151	NATB 5906	157	30	47	23	25	0.3	35	
35	NATA 5907	250	NATB 5907	260	35	55	27	30	0.6	42	
40	NATA 5908	355	NATB 5908	375	40	62	30	34	0.6	48	
45	NATA 5909	410	NATB 5909	435	45	68	30	34	0.6	55	
50	NATA 5910	420	NATB 5910	445	50	72	30	34	0.6	58	
55	NATA 5911	585	NATB 5911	615	55	80	34	38	1	63	
60	NATA 5912	625	NATB 5912	660	60	85	34	38	1	68	
65	NATA 5913	665	NATB 5913	710	65	90	34	38	1	75	
70	NATA 5914	1 070	NATB 5914	1 130	70	100	40	45	1	80	

Notes<sup>(1)</sup> Minimum allowable value of chamfer dimension  $r$   
<sup>(2)</sup> Allowable rotational speed applies to oil lubrication. For grease lubrication, a maximum of 60% of this value is allowable.  
 Remarks1. The outer ring has an oil groove and an oil hole.  
 2. No grease is prepacked. Perform proper lubrication.

Standard mounting dimensions mm		Basic dynamic load rating C		Basic static load rating C <sub>0</sub>		Allowable rotational speed <sup>(2)</sup> min <sup>-1</sup>
$d_a$ Min.	$D_a$ Max.	Radial N	Axial N	Radial N	Axial N	
17	26	7 710	1 900	10 200	2 920	
19	28	8 220	2 050	11 500	3 340	18 000
22	35	14 300	3 810	18 400	6 110	16 000
27	40	15 800	4 300	22 100	7 520	13 000
32	45	17 700	4 550	26 800	8 460	11 000
39	51	24 000	4 890	42 100	9 870	9 500
44	58	30 600	5 350	60 400	11 800	8 500
49	64	32 600	5 450	68 500	12 700	7 000
54	68	33 600	5 660	72 500	13 600	7 000
60	75	39 500	10 400	74 400	24 700	6 500
65	80	41 800	10 700	82 200	26 700	6 000
70	85	43 800	11 000	90 200	28 700	5 500
75	95	56 400	13 500	127 000	35 000	5 000

**G**  
 NAX  
 NBX  
 NATA  
 NATB