

冲压外圈型滚针轴承

- 附带保持架的冲压外圈型滚针轴承
- 润滑脂固定满滚子冲压外圈型滚针轴承



结构与特长

IKO冲压外圈型滚针轴承使用特殊薄钢板经精密冲压加工并渗碳淬火的冲压外圈，故其是滚针轴承中截面高度最小，轻量而且额定负载大的轴承。

此款轴承有附带保持架和附带满滚子两种，可根据轴承的工作条件选择。附带保持架的结构由于保持架和推力环精确导向针状滚子，适宜于高速旋转。而满滚子结构适宜于重负荷低速旋转。

与轴承座的安装采用压入固定，故无需轴向固定，用途广泛，最适合于讲究经济性的批量生产产品。

冲压外圈型滚针轴承的结构

附带保持架标准型

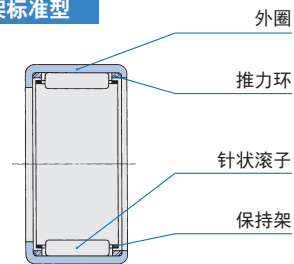

附带保持架一端密闭型

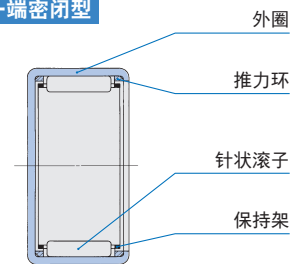

附带保持架两侧密封型

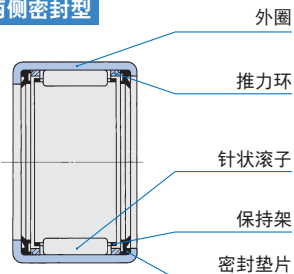

润滑脂固定满滚子

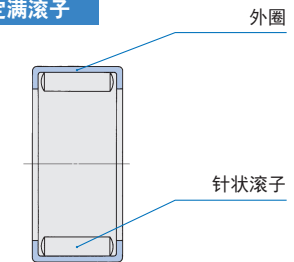

型号

冲压外圈型滚针轴承的型号如表1所示。

表1 轴承的型号

分类	轴承的型号	附带保持架			满滚子 润滑脂固定
		标准型	一端密封型	两侧密封型 ⁽¹⁾	
公制系列	—	TLA...Z	TLAM	TLA...UU	YTL
	重负荷用	TA...Z	TAM	—	YT
英制系列	—	BA...Z	BAM	—	YB
	重负荷用	BHA...Z	BHAM	—	YBH

注⁽¹⁾如果需要重负载用的密封型及一端密封的单侧密封型，请向IKO咨询。

备注 滚动体为双列的型号标记上附注“W”来表示。
例 TAW 5045 Z

附带保持架的冲压外圈型滚针轴承

标准型

这种型号轴承的外圈的刻印侧轴环内径与轴的间隙小，能防止润滑脂泄漏和异物侵入，具备防尘作用，用途范围广。

一端密封型

这种型号轴承为外圈的一端完全密封，最适合于轴端的轴承部密封用途。

另外，外圈密封侧的端面形状有两种，由尺寸表中所示图纸的 t_1 为 $F_w > 22$ 、 t_2 为 $F_w \leq 22$ 来区分适用。

两侧密封型

此款轴承加宽了标准型外圈宽度，轴环的内侧装配有由加固环与特殊合成橡胶形成的密封垫片，具有防止润滑脂泄漏和异物侵入的作用。

润滑脂固定满滚子 冲压外圈型滚针轴承

此款轴承为外圈的整个轨道宽度都与滚子接触的满滚子轴承，能经受住大轴承负载，最适合于低中速旋转及摆动运行的工作部位。此外，为了固定滚子已封入了润滑脂，安装后即可运行。

公称型号

冲压外圈型滚针轴承的公称型号由型号标记和尺寸组成，其排列例如下所示。

附带内圈使用时使用尺寸表中所示的搭配内圈，这时的排列例也如下所示。但交货时内圈为分离未装配。

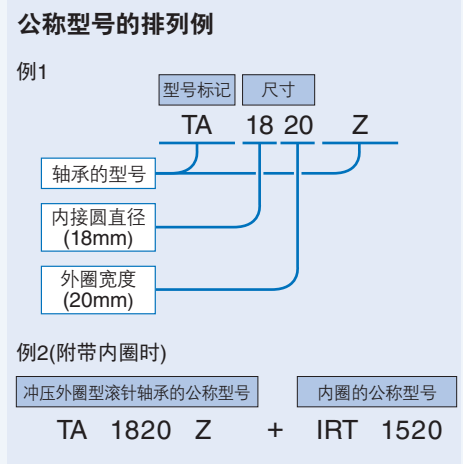

精度

冲压外圈型滚针轴承的外圈为薄壁，不可避免地会因热处理而变形，故直接测定实物是不妥当的。因此，将轴承压入表2.1和表2.2的环规后用表2.1和表2.2的塞规或锥形规测定内接圆直径。

外圈宽度C的容许公差如表3所示。

表2.1 公制单位的测定规尺寸 单位 mm

F_w 公称 内接圆直径	环规		塞规	
	TA...Z ⁽¹⁾	TLA...Z ⁽²⁾	通过	止住
4	—	7.981	4.004	4.016
5	—	8.981	5.004	5.016
6	—	9.981	6.004	6.016
7	—	10.977	7.005	7.020
8	14.992	11.977	8.005	8.020
9	15.992	12.977	9.005	9.020
10	16.992	13.977	10.005	10.020
12	18.991	15.977 ⁽³⁾ 17.977 ⁽³⁾	12.006	12.024
13	—	18.972	13.006	13.024
14	21.991	19.972	14.006	14.024
15	21.991	20.972	15.006	15.024
16	23.991	21.972	16.006	16.024
17	23.991	22.972	17.006	17.024
18	24.991	23.972	18.006	18.024
19	26.991	—	19.007	19.028
20	26.991 ⁽⁴⁾ 27.991 ⁽⁴⁾	25.972	20.007	20.028
21	28.991	—	21.007	21.028
22	28.991 ⁽⁵⁾ 29.991 ⁽⁵⁾	27.972	22.007	22.028
24	30.989 ⁽⁶⁾ 31.989 ⁽⁶⁾	—	24.007	24.028
25	32.989	31.967	25.007	25.028
26	33.989	—	26.007	26.028
28	36.989	34.967	28.007	28.028
29	37.989	—	29.007	29.028
30	39.989	36.967	30.007	30.028
32	41.989	—	32.009	32.034
35	44.989	41.967	35.009	35.034
37	46.989	—	37.009	37.034
38	47.989	—	38.009	38.034
40	49.989	46.967	40.009	40.034
45	54.988	51.961	45.009	45.034
50	61.988	57.961	50.009	50.034
55	66.988	62.961	55.010	55.040
60	71.988	—	60.010	60.040
62	73.988	—	62.010	62.040
65	76.988	—	65.010	65.040
70	81.987	—	70.010	70.040

注⁽¹⁾ TAM, YT也相同。
⁽²⁾ TLAM, YTL, TLA...UU也相同。
⁽³⁾ 上栏表示TLA1210Z, 下栏表示TLA1212Z。
⁽⁴⁾ 下栏表示TA202820Z, 上栏表示其他。
⁽⁵⁾ 下栏表示TA223016Z, TA223020Z, 上栏表示其他。
⁽⁶⁾ 下栏表示TA243216Z, TA243220Z, 上栏表示其他。

表2.2 英制单位的测定规尺寸 单位 mm

F_w 公称 内接圆直径	环规		塞规	
	BA...Z ⁽¹⁾	BHA...Z ⁽²⁾	通过	止住
3.969	7.155	—	3.990	4.016
4.762	8.730	—	4.783	4.808
6.350	11.125	—	6.388	6.414
7.938	12.713	14.300	7.976	8.001
9.525	14.300	15.888	9.563	9.588
11.112	15.888	17.475	11.151	11.176
12.700	17.475	19.063	12.738	12.764
14.288	19.063	20.650	14.326	14.351
15.875	20.650	22.238	15.913	15.938
17.462	22.238	23.825	17.501	17.526
19.050	25.387	26.975	19.063	19.088
20.638	26.975	28.562	20.650	20.676
22.225	28.562	30.150	22.238	22.263
23.812	30.150	—	23.825	23.851
25.400	31.737	33.325	25.413	25.438
26.988	33.325	—	27.000	27.026
28.575	34.912	38.087	28.588	28.613
30.162	38.087	—	30.175	30.201
31.750	38.087	41.262	31.763	31.788
33.338	41.262	—	33.350	33.378
34.925	41.262	44.437	34.938	34.966
38.100	47.612	—	38.113	38.143
41.275	50.787	—	41.288	41.318
44.450	53.962	57.137	44.463	44.496
47.625	57.137	—	47.638	47.671
50.800	60.312	—	50.815	50.848
52.388	—	64.280	52.413	52.451
53.975	63.487	—	53.990	54.028
57.150	66.662	—	57.165	57.203
66.675	76.187	—	66.700	66.738
69.850	79.362	—	69.875	69.914

注⁽¹⁾ BAM, YB也相同。
⁽²⁾ BHAM, YBH也相同。

表3 外圈宽度C的容许公差 单位 mm

分类	尺寸公差
公制单位	0
	-0.20
英制单位	0
	-0.25

配合

冲压外圈型滚针轴承要在压入轴承座后才能获得正式的尺寸精度。由于是薄壁外圈，所以轴承座的尺寸、形状及刚性直接影响到轴承的精度，应充分予以注意。此外，安装于轴及轴承座时的径向间隙因轴承、轴及轴承座的各自的容许公差而异。

冲压外圈型滚针轴承推荐的配合如表4所示。

表4 推荐的配合

轴承的型号	轴承座材质	公差等级		轴承座
		轴 ⁽¹⁾		
		无内圈	带内圈	
TA...Z、BA...Z、BHA...Z TAM、BAM、BHAM YT、YB、YBH	钢 铸铁	h6	k5(j5)	J7
	轻型合金 (薄壁钢管)	h6	k5(j5)	M7(N7)
TLA...Z、TLAM、YTL TLA...UU	钢 铸铁	h6	k5(j5)	N7
	轻型合金 (薄壁钢管)	h6	k5(j5)	R7(S7)

注⁽¹⁾ 如果轴承座的材质为轻型合金及薄壁钢管，其壁厚和形状对内接圆直径的影响特别大，故需要在量产之前进行装配试验，确认尺寸变化后，确定轴径的容许公差以基本达到普通间隙。

表5 安装后的径向间隙的计算例

单位 mm

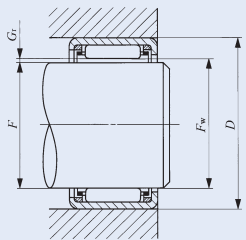
计算步骤	TLA 2020 Z 之例
	 <p>① 压入环时轴承内接圆直径的尺寸 环规尺寸(D₀): 参照第71页上的表2.1和表2.2 最大内接圆直径(F_{w max}): 塞规止住尺寸 最小内接圆直径(F_{w min}): 塞规通过尺寸</p>
<p>② 轴承座孔尺寸 最大轴承座孔(D_{max}): 参照尺寸表 最小轴承座孔(D_{min}): 参照尺寸表</p>	根据第81页上的尺寸表 D _{max} = 25.993 D _{min} = 25.972
<p>③ 压入轴承座时轴承内接圆直径的尺寸 最大内接圆直径(F_{wc max}) = (D_{max} - D₀) + F_{w max} 最小内接圆直径(F_{wc min}) = (D_{min} - D₀) + F_{w min}</p>	根据计算公式 F _{wc max} = 20.049 F _{wc min} = 20.007
<p>④ 轴的尺寸 最大轴径(F_{max}): 参照尺寸表 最小轴径(F_{min}): 参照尺寸表</p>	根据第81页上的尺寸表 F _{max} = 20.000 F _{min} = 19.987
<p>⑤ 安装后的径向间隙 最大径向间隙(G_{r max}) = F_{wc max} - F_{min} 最小径向间隙(G_{r min}) = F_{wc min} - F_{max}</p>	根据计算公式 G _{r max} = 0.062 G _{r min} = 0.007 安装后的径向间隙 0.007 ~ 0.062mm。

D : 轴承座直径
F_w : 内接圆直径
F : 轴径
G_r : 径向间隙

表5所示为安装后的径向间隙的计算例。此计算例适合于没有内圈，厚壁的钢或铸铁轴承座。如果轴承座为轻型合金及薄壁钢管等的话，需要通过实测确认尺寸。

此外，一般要缩小径向间隙的话，推荐增大轴径而不是缩小轴径。

润滑

封入润滑脂的轴承如表6所示。封入的润滑脂为出光昭和壳牌(株)的爱万利润滑脂S2。

对没有封入润滑脂的轴承，请进行适当的润滑后使用，如果不加油，会增加滑动接触面的磨损，缩短使用寿命。

油孔

要在冲压外圈型滚针轴承上设油孔时，订货时请在公称型号的最后标注“OH”。

例 TA 2525 Z OH

但是，附带油孔的标记“OH”标示于包装箱等上，在轴承上不作标示。此外，如需要附带多个油孔，请向IKO咨询。

表6 封入润滑脂的轴承

○: 封入 ×: 未封入

分类	轴承的型号	附带保持架			满滚子 润滑脂固定
		标准型	一端密闭型	两侧密封型	
公制系列	TLA、TLAM、YTL	×	×	○	○
	TA、TAM、YT	×	×	—	○
英制系列	BA、BAM、YB	×	×	—	○
	BHA、BHAM、YBH	×	×	—	○

静态安全系数

冲压外圈型滚针轴承由于使用薄钢板经精密冲压加工并渗碳淬火后的外圈，故需要避免过大的负载。通常，静态安全系数需要超过3。

轴及轴承座的规格

冲压外圈型滚针轴承一般不带内圈使用，此时轨道面的表面硬度以58~64HRC为宜，表面光洁度以0.2μmR_a以内为宜。如果工作条件不十分苛刻，也可在表面光洁度0.8μmR_a以下的条件下使用。

如果表面硬度低，则需要用第23页上的硬度系数对额定负荷进行修正。如果不能对轴进行热处理和磨削精加工，建议使用IKO冲压外圈型滚针轴承用内圈(参照第282页)。

安装

冲压外圈型滚针轴承的安装使用图1所示的工具，轴承的刻印侧朝上稳稳地压入。外圈为薄壁，切勿用锤子直接敲击。

冲压外圈型滚针轴承的外圈是用过盈配合结实压入轴承座的，故无需固定轴向定位。安装例如图2所示。



图1 安装工具例



图2 安装例

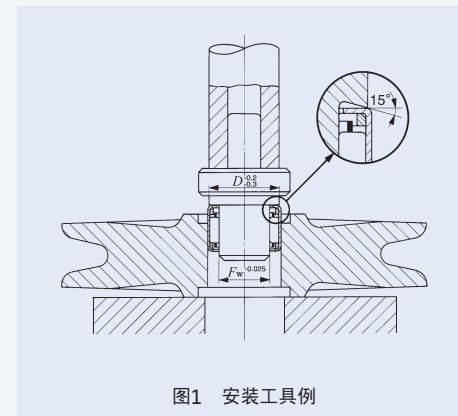

TA...Z TLA...Z

TAM TLAM

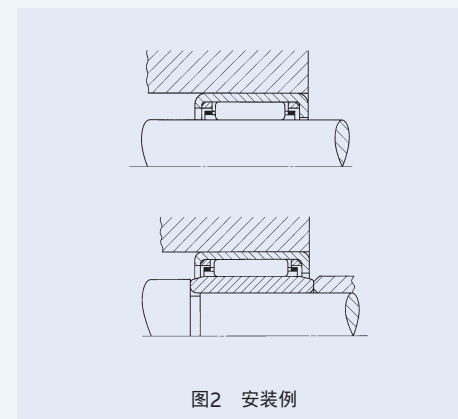
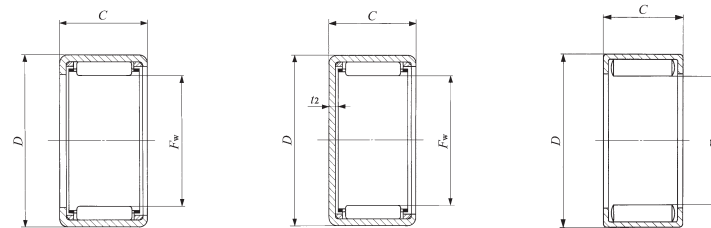
YT YTL

轴径4-10mm

轴径 mm	公称型号									
	标准型	质量 (参考) g	一端密闭型	质量 (参考) g	标准型	质量 (参考) g	一端密闭型	质量 (参考) g	润滑脂固定	质量 (参考) g
4	—	—	—	—	TLA 48 Z	1.54	TLAM 48	1.67	—	—
	—	—	—	—	—	—	—	—	YTL 48	1.73
5	—	—	—	—	TLA 59 Z	1.9	TLAM 59	2	—	—
	—	—	—	—	—	—	—	—	YTL 59	2.4
6	—	—	—	—	TLA 69 Z	2.2	TLAM 69	2.3	—	—
7	—	—	—	—	TLA 79 Z	2.5	TLAM 79	2.7	—	—
8	—	—	—	—	TLA 810 Z	3.1	TLAM 810	3.3	—	—
	TA 810 Z	6.7	TAM 810	7.1	—	—	—	—	—	—
	TA 815 Z	9.7	TAM 815	10.1	—	—	—	—	—	—
	TA 820 Z	12.9	TAM 820	13.3	—	—	—	—	—	—
	—	—	—	—	—	—	—	—	YT 810	7.7
9	—	—	—	—	TLA 910 Z	3.4	TLAM 910	3.6	—	—
	—	—	—	—	TLA 912 Z	4	TLAM 912	4.3	—	—
	TA 912 Z	8.7	TAM 912	9.2	—	—	—	—	—	—
	TA 916 Z	11.4	TAM 916	11.9	—	—	—	—	YT 912	10.1
10	—	—	—	—	TLA 1010 Z	3.7	TLAM 1010	4	—	—
	—	—	—	—	TLA 1012 Z	4.4	TLAM 1012	4.8	—	—
	—	—	—	—	TLA 1015 Z	5.5	TLAM 1015	5.9	—	—
	TA 1010 Z	7.9	TAM 1010	8.5	—	—	—	—	—	—
	TA 1012 Z	9.3	TAM 1012	10	—	—	—	—	—	—
	TA 1015 Z	11.5	TAM 1015	12.2	—	—	—	—	—	—
	TA 1020 Z	15.4	TAM 1020	16	—	—	—	—	—	—

主要尺寸 mm				标准安装尺寸 mm				基本额定 动负荷 C	基本额定 静负荷 C ₀	容 许 ⁽¹⁾ 转 速 min ⁻¹	搭配的内圈
F _w	D	C	t ₂ 最大	轴径 h6		轴承座直径 N7					
				最大	最小	最大	最小	N	N		
4	8	8	1	4.000	3.992	—	—	1 350	1 010	75 000	—
4	8	8	—	—	—	7.996	7.981	3 010	2 900	40 000	—
5	9	9	1	5.000	4.992	—	—	1 880	1 600	65 000	—
5	9	9	—	—	—	8.996	8.981	4 320	4 750	30 000	—
6	10	9	1	6.000	5.992	—	—	2 100	1 900	55 000	—
7	11	9	1	7.000	6.991	—	—	2 490	2 450	50 000	—
8	12	10	1	8.000	7.991	—	—	3 320	3 670	45 000	—
8	15	10	1.3	—	—	—	—	3 470	2 880	45 000	—
8	15	15	1.3	8.000	7.991	15.010	14.992	5 780	5 570	45 000	—
8	15	20	1.3	—	—	—	—	8 340	8 920	45 000	—
8	15	10	—	—	—	—	—	7 530	7 950	19 000	—
9	13	10	1	9.000	8.991	—	—	3 500	4 040	45 000	—
9	13	12	1	—	—	12.995	12.977	4 460	5 510	45 000	—
9	16	12	1.3	9.000	8.991	16.010	15.992	5 140	4 880	45 000	—
9	16	16	1.3	—	—	—	—	6 960	7 210	45 000	—
9	16	12	—	—	—	—	—	9 690	11 200	17 000	—
10	14	10	1	—	—	—	—	3 870	4 740	40 000	IRT 710
10	14	12	1	10.000	9.991	—	—	4 920	6 460	40 000	IRT 712
10	14	15	1	—	—	13.995	13.977	6 390	9 040	40 000	IRT 715
10	17	10	1.3	—	—	—	—	4 150	3 780	40 000	IRT 710
10	17	12	1.3	10.000	9.991	17.010	16.992	5 590	5 540	40 000	IRT 712
10	17	15	1.3	—	—	—	—	6 920	7 300	40 000	IRT 715
10	17	20	1.3	—	—	—	—	9 990	11 700	40 000	—

1N=0.102kgf

注(1) 容许转速适用于润滑油润滑。润滑脂润滑的话可容许到该值的60%。

备注 润滑脂固定满滚子冲压外圈型滚针轴承已封入润滑脂。标准型及一端密闭型未封入润滑脂，请适当润滑后使用。

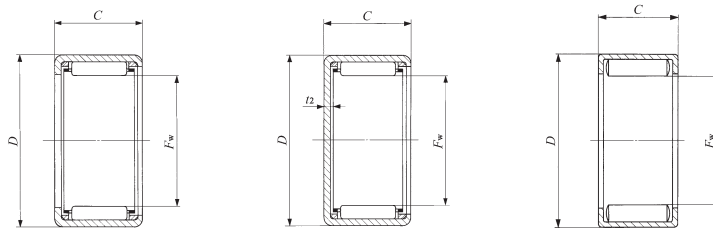

TA...Z TLA...Z

TAM TLAM

YT YTL

轴径12-15mm

轴径 mm	公称型号									
	标准型	质量 (参考) g	一端密封型	质量 (参考) g	标准型	质量 (参考) g	一端密封型	质量 (参考) g	润滑脂固定	质量 (参考) g
12	—	—	—	—	TLA 1210 Z	4.3	TLAM 1210	4.7	—	—
	—	—	—	—	—	—	—	—	YTL 1210	5.1
	—	—	—	—	TLA 1212 Z	8.6	TLAM 1212	9.4	—	—
	TA 1212 Z	10.5	TAM 1212	11.5	—	—	—	—	—	—
	TA 1215 Z	13.1	TAM 1215	14	—	—	—	—	—	—
	TA 1220 Z	17.3	TAM 1220	18.3	—	—	—	—	—	—
TA 1225 Z	21.5	TAM 1225	22.5	—	—	—	—	—	—	
—	—	—	—	—	—	—	—	YT 1212	12.8	—
13	—	—	—	—	TLA 1312 Z	9.2	TLAM 1312	10.1	—	—
14	—	—	—	—	TLA 1412 Z	9.8	TLAM 1412	10.8	—	—
	—	—	—	—	TLA 1416 Z	13.2	TLAM 1416	14.3	—	—
	TA 1416 Z	18.4	TAM 1416	19.6	—	—	—	—	—	—
TA 1420 Z	23	TAM 1420	24	—	—	—	—	—	—	
15	—	—	—	—	TLA 1512 Z	10.4	TLAM 1512	11.5	—	—
	—	—	—	—	TLA 1516 Z	14	TLAM 1516	15.2	—	—
	—	—	—	—	TLA 1522 Z	19.1	TLAM 1522	20.5	—	—
	TA 1510 Z	10.8	TAM 1510	12.3	—	—	—	—	—	—
	TA 1512 Z	12.9	TAM 1512	14.3	—	—	—	—	—	—
	TA 1515 Z	15.9	TAM 1515	17.3	—	—	—	—	—	—
TA 1520 Z	21	TAM 1520	22.5	—	—	—	—	—	—	
TA 1525 Z	25	TAM 1525	26.5	—	—	—	—	—	—	

主要尺寸 mm				标准安装尺寸 mm						基本额定 动负荷 C	基本额定 静负荷 C ₀	容 许 ⁽¹⁾ 转 速 min ⁻¹	搭配的内圈
F _w	D	C	t ₂ 最大	轴径 h6		轴承座直径							
				最大	最小	最大 J7	最小	最大 N7	最小	N	N		
12	16	10	1	12.000	11.989	—	—	15.995	15.977	4 350	5 810	35 000	IRT 810
12	16	10	—	—	—	—	—	—	—	7 470	11 800	13 000	IRT 810
12	18	12	1.3	12.000	11.989	—	—	17.995	17.977	6 420	7 490	35 000	IRT 812
12	19	12	1.3	—	—	—	—	—	—	6 000	6 310	35 000	IRT 812
12	19	15	1.3	—	—	—	—	—	—	7 440	8 320	35 000	IRT 815
12	19	20	1.3	12.000	11.989	19.012	18.991	—	—	10 700	13 300	35 000	—
12	19	25	1.3	—	—	—	—	—	—	13 800	18 300	35 000	—
12	19	12	—	—	—	—	—	—	—	11 800	15 200	13 000	IRT 812
13	19	12	1.3	13.000	12.989	—	—	18.993	18.972	6 760	8 170	30 000	IRT 1012
14	20	12	1.3	14.000	13.989	—	—	19.993	19.972	7 080	8 840	30 000	IRT 1012-2
14	20	16	1.3	—	—	—	—	—	—	8 950	12 000	30 000	IRT 1016-2
14	22	16	1.3	14.000	13.989	22.012	21.991	—	—	10 500	12 000	30 000	IRT 1016-2
14	22	20	1.3	—	—	—	—	—	—	13 900	17 200	30 000	IRT 1020-2
15	21	12	1.3	—	—	—	—	—	—	7 380	9 520	25 000	IRT 1212
15	21	16	1.3	15.000	14.989	—	—	20.993	20.972	9 330	12 900	25 000	IRT 1216
15	21	22	1.3	—	—	—	—	—	—	13 600	20 900	25 000	IRT 1222
15	22	10	1.3	—	—	—	—	—	—	5 290	5 680	25 000	IRT 1010-1
15	22	12	1.3	—	—	—	—	—	—	7 120	8 310	25 000	IRT 1012-1
15	22	15	1.3	15.000	14.989	22.012	21.991	—	—	8 830	11 000	25 000	IRT 1015-1
15	22	20	1.3	—	—	—	—	—	—	12 700	17 600	25 000	IRT 1020-1
15	22	25	1.3	—	—	—	—	—	—	16 300	24 200	25 000	IRT 1025-1

注(1) 容许转速适用于润滑油润滑。润滑脂润滑的话可容许到该值的60%。

备注 润滑脂固定满滚子冲压外圈型滚针轴承已封入润滑脂。标准型及一端密封型未封入润滑脂，请适当润滑后使用。

1N=0.102kgf

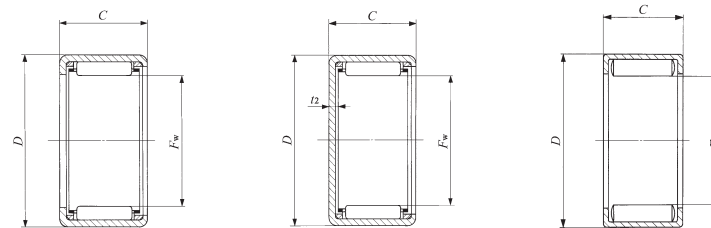

TA...Z TLA...Z

TAM TLAM

YT

轴径16-19mm

轴径 mm	公称型号									
	标准型	质量 (参考) g	一端密闭型	质量 (参考) g	标准型	质量 (参考) g	一端密闭型	质量 (参考) g	润滑脂固定	质量 (参考) g
16	—	—	—	—	TLA 1612 Z	10.9	TLAM 1612	12.2	—	—
	—	—	—	—	TLA 1616 Z	14.8	TLAM 1616	16.1	—	—
17	—	—	—	—	TLA 1712 Z	11.5	TLAM 1712	13	—	—
	TA 1616 Z	20	TAM 1616	22	—	—	—	—	—	—
18	—	—	—	—	TLA 1812 Z	12	TLAM 1812	13.7	—	—
	—	—	—	—	TLA 1816 Z	16.2	TLAM 1816	17.9	—	—
19	TA 1916 Z	23	TAM 1916	25.5	—	—	—	—	—	—
	TA 1920 Z	29	TAM 1920	31	—	—	—	—	—	—

主要尺寸 mm				标准安装尺寸 mm						基本额定 动负荷 C	基本额定 静负荷 C ₀	容 许 ⁽¹⁾ 转 速 min ⁻¹	搭配的内圈
F _w	D	C	t ₂ 最大	轴径 h6		轴承座直径							
				最大	最小	J7		N7		N	N		
16	22	12	1.3	16.000	15.989	—	—	21.993	21.972	7 670	10 200	25 000	IRT 1212-1
16	22	16	1.3	—	—	—	—	—	—	9 700	13 800	25 000	IRT 1216-1
16	22	22	1.3	—	—	—	—	—	—	14 200	22 400	25 000	IRT 1222-1
16	24	16	1.3	16.000	15.989	24.012	23.991	—	—	11 100	13 300	25 000	IRT 1216-1
16	24	20	1.3	—	—	—	—	—	—	14 700	19 100	25 000	IRT 1220-1
17	23	12	1.3	17.000	16.989	—	—	22.993	22.972	7 960	10 900	25 000	—
17	24	15	1.3	—	—	—	—	—	—	9 660	12 700	25 000	IRT 1215-2
17	24	20	1.3	—	—	—	—	—	—	13 900	20 400	25 000	IRT 1220-2
17	24	25	1.3	17.000	16.989	24.012	23.991	—	—	17 900	28 100	25 000	IRT 1225-2
17	24	15	—	—	—	—	—	—	—	16 600	26 000	9 000	IRT 1215-2
17	24	25	—	—	—	—	—	—	—	27 200	49 000	9 000	IRT 1225-2
18	24	12	1.3	18.000	17.989	—	—	23.993	23.972	8 230	11 500	20 000	IRT 1512
18	24	16	1.3	—	—	—	—	—	—	10 400	15 600	20 000	IRT 1516
18	25	13	1.3	—	—	—	—	—	—	9 100	12 000	20 000	IRT 1513
18	25	15	1.3	—	—	—	—	—	—	10 100	13 600	20 000	IRT 1515
18	25	17	1.3	18.000	17.989	25.012	24.991	—	—	11 900	16 900	20 000	IRT 1517
18	25	19	1.3	—	—	—	—	—	—	13 700	20 200	20 000	IRT 1519
18	25	20	1.3	—	—	—	—	—	—	14 500	21 800	20 000	IRT 1520
18	25	25	1.3	—	—	—	—	—	—	18 600	30 000	20 000	IRT 1525
19	27	16	1.3	19.000	18.987	27.012	26.991	—	—	12 200	15 700	20 000	IRT 1516-1
19	27	20	1.3	—	—	—	—	—	—	16 100	22 600	20 000	IRT 1520-1

注(1) 容许转速适用于润滑油润滑。润滑脂润滑的话可容许到该值的60%。
备注 润滑脂固定满滚子冲压外圈型滚针轴承已封入润滑脂。标准型及一端密闭型未封入润滑脂，请适当润滑后使用。

1N=0.102kgf

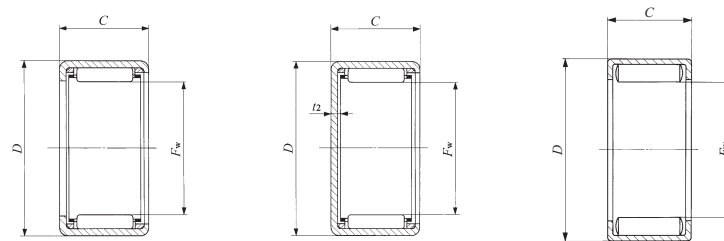

TA...Z TLA...Z

TAM TLAM

YT

轴径20-21mm

轴径 mm	公称型号									
	标准型	质量 (参考) g	一端密闭型	质量 (参考) g	标准型	质量 (参考) g	一端密闭型	质量 (参考) g	润滑脂固定	质量 (参考) g
20	—	—	—	—	TLA 2012 Z	13.2	TLAM 2012	15.2	—	—
	—	—	—	—	TLA 2016 Z	17.8	TLAM 2016	19.9	—	—
	—	—	—	—	TLA 2020 Z	22	TLAM 2020	24	—	—
	—	—	—	—	TLA 2030 Z	33	TLAM 2030	35	—	—
	TA 2015 Z	20	TAM 2015	22.5	—	—	—	—	—	—
	TA 2020 Z	26.5	TAM 2020	29	—	—	—	—	—	—
	TA 2025 Z	33	TAM 2025	35.5	—	—	—	—	—	—
	TA 2030 Z	39.5	TAM 2030	42	—	—	—	—	—	—
	—	—	—	—	—	—	—	—	YT 2015	23.5
	—	—	—	—	—	—	—	—	YT 2025	41
	TA 202820 Z	30	TAM 202820	32.5	—	—	—	—	—	—
	—	—	—	—	—	—	—	—	YT 202820	37.5
21	TA 2116 Z	25	TAM 2116	28	—	—	—	—	—	—
	TA 2120 Z	31.5	TAM 2120	34.5	—	—	—	—	—	—
	—	—	—	—	—	—	—	—	YT 2116	31
	—	—	—	—	—	—	—	—	YT 2120	39

主要尺寸 mm				标准安装尺寸 mm				基本额定 动负荷 C	基本额定 静负荷 C ₀	容 许 ⁽¹⁾ 转 速 min ⁻¹	搭配的内圈		
F _w	D	C	t ₂ 最大	轴径 h6		轴承座直径							
				最大	最小	最大 J7	最小	最大 N7	最小				
20	26	12	1.3	20.000	19.987	—	—	25.993	25.972	8 740	12 900	20 000	—
20	26	16	1.3							11 100	17 500	20 000	IRT 1716
20	26	20	1.3							14 500	24 700	20 000	IRT 1720
20	26	30	1.3							22 300	42 900	20 000	IRT 1730
20	27	15	1.3							20.000	19.987	27.012	26.991
20	27	20	1.3	15 000	23 400	20 000	IRT 1520-2						
20	27	25	1.3	19 200	32 200	20 000	IRT 1525-2						
20	27	30	1.3	23 100	41 000	20 000	IRT 1530-2						
20	27	15	—	18 400	30 900	7 500	IRT 1515-2						
20	27	25	—	30 000	58 300	7 500	IRT 1525-2						
20	28	20	1.3	20.000	19.987	28.012	27.991	—	—				
20	28	20	—							26 800	44 600	7 500	IRT 1520-2
21	29	16	1.3	21.000	20.987	29.012	28.991	—	—	13 300	18 100	19 000	IRT 1716-1
21	29	20	1.3							17 600	25 900	19 000	IRT 1720-1
21	29	16	—							22 100	35 200	7 000	IRT 1716-1
21	29	20	—							27 500	46 800	7 000	IRT 1720-1

注(1) 容许转速适用于润滑油润滑。润滑脂润滑的话可容许到该值的60%。
备注 润滑脂固定满滚子冲压外圈型滚针轴承已封入润滑脂。标准型及一端密闭型未封入润滑脂，请适当润滑后使用。

1N=0.102kgf

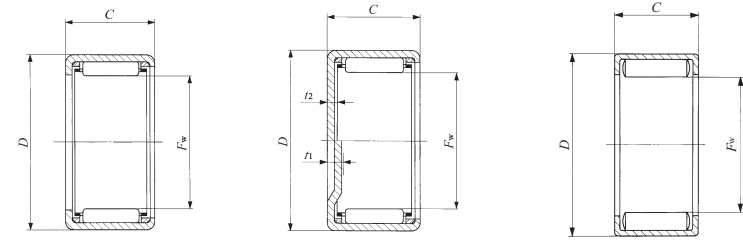

TA...Z TLA...Z

TAM TLAM
t₁ (F_w ≥ 24)
t₂ (F_w ≤ 22)

YT

轴径22-24mm

轴径 mm	公称型号									
	标准型	质量 (参考) g	一端密闭型	质量 (参考) g	标准型	质量 (参考) g	一端密闭型	质量 (参考) g	润滑脂固定	质量 (参考) g
22	—	—	—	—	TLA 2212 Z	15.6	TLAM 2212	18.1	—	—
	—	—	—	—	TLA 2216 Z	21.5	TLAM 2216	24	—	—
	—	—	—	—	TLA 2220 Z	26.5	TLAM 2220	29	—	—
	TA 2210 Z	15	TAM 2210	18.1	—	—	—	—	—	—
	TA 2215 Z	21.5	TAM 2215	24.5	—	—	—	—	—	—
	TA 2220 Z	29	TAM 2220	32	—	—	—	—	—	—
	TA 2225 Z	35.5	TAM 2225	38.5	—	—	—	—	—	—
	TA 2230 Z	42.5	TAM 2230	45.5	—	—	—	—	—	—
	TA 223016 Z	26	TAM 223016	29	—	—	—	—	—	—
	TA 223020 Z	32.5	TAM 223020	35.5	—	—	—	—	—	—
—	—	—	—	—	—	—	—	YT 223016	32	
—	—	—	—	—	—	—	—	YT 223020	40.5	
24	TA 2420 Z	31	TAM 2420	35	—	—	—	—	—	—
	TA 2428 Z	43.5	TAM 2428	47	—	—	—	—	—	—
	—	—	—	—	—	—	—	—	YT 2428	54
	TA 243216 Z	28	TAM 243216	32	—	—	—	—	—	—
	TA 243220 Z	35.5	TAM 243220	39	—	—	—	—	—	—
	—	—	—	—	—	—	—	—	YT 243216	34.5
—	—	—	—	—	—	—	—	YT 243220	43.5	

主要尺寸 mm				标准安装尺寸 mm				基本额定 动负荷 C	基本额定 静负荷 C ₀	容 许 ⁽¹⁾ 转 速 min ⁻¹	搭配的内圈		
F _w	D	C	t ₁ , t ₂ 最大	轴径 h6		轴承座直径							
				最大	最小	最大 J7	最小	最大 N7	最小	N	N	min ⁻¹	
22	28	12	1.3							9 230	14 300	18 000	—
22	28	16	1.3	22.000	21.987	—	—	27.993	27.972	11 700	19 300	18 000	IRT 1716-2
22	28	20	1.3							15 300	27 300	18 000	IRT 1720-2
22	29	10	1.3							6 650	8 500	18 000	IRT 1710-2
22	29	15	1.3							11 100	16 400	18 000	IRT 1715-2
22	29	20	1.3	22.000	21.987	29.012	28.991	—	—	16 000	26 300	18 000	IRT 1720-2
22	29	25	1.3							19 700	34 300	18 000	IRT 1725-2
22	29	30	1.3							23 800	43 700	18 000	IRT 1730-2
22	30	16	1.3							13 200	18 200	18 000	IRT 1716-2
22	30	20	1.3	22.000	21.987	30.012	29.991	—	—	17 500	26 100	18 000	IRT 1720-2
22	30	16	—							22 600	36 800	7 000	IRT 1716-2
22	30	20	—							28 200	48 900	7 000	IRT 1720-2
24	31	20	3.4							17 000	29 200	16 000	IRT 2020
24	31	28	3.4	24.000	23.987	31.014	30.989	—	—	24 500	46 700	16 000	IRT 2028
24	31	28	—							36 800	79 900	6 500	IRT 2028
24	32	16	3.4							14 200	20 500	16 000	IRT 2016
24	32	20	3.4	24.000	23.987	32.014	31.989	—	—	18 800	29 400	16 000	IRT 2020
24	32	16	—							23 700	40 100	6 500	IRT 2016
24	32	20	—							29 500	53 200	6 500	IRT 2020

注(1) 容许转速适用于润滑油润滑。润滑脂润滑的话可容许到该值的60%。
备注 润滑脂固定满滚子冲压外圈型滚针轴承已封入润滑脂。标准型及一端密闭型未封入润滑脂，请适当润滑后使用。

1N=0.102kgf

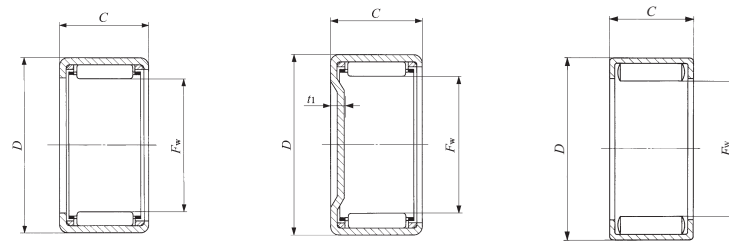

TA...Z TLA...Z

TAM TLAM

YT YTL

轴径25 - 28mm

轴径 mm	公称型号									
	标准型	质量 (参考) g	一端密闭型	质量 (参考) g	标准型	质量 (参考) g	一端密闭型	质量 (参考) g	润滑脂固定	质量 (参考) g
25	—	—	—	—	TLA 2512 Z	19.7	TLAM 2512	23.5	—	—
	—	—	—	—	TLA 2516 Z	26	TLAM 2516	29.5	—	—
	—	—	—	—	TLA 2520 Z	32	TLAM 2520	36	—	—
	—	—	—	—	TLA 2526 Z	41.5	TLAM 2526	45.5	—	—
	—	—	—	—	TLAW2538Z	58.5	TLAMW2538	62	—	—
	—	—	—	—	—	—	—	—	YTL 2526	51.5
	TA 2510 Z	19.1	TAM 2510	23	—	—	—	—	—	—
	TA 2515 Z	28.5	TAM 2515	32.5	—	—	—	—	—	—
	TA 2520 Z	36.5	TAM 2520	40.5	—	—	—	—	—	—
	TA 2525 Z	45.5	TAM 2525	49	—	—	—	—	—	—
	TA 2530 Z	54.5	TAM 2530	58.5	—	—	—	—	—	—
	—	—	—	—	—	—	—	—	YT 2510	22.5
	—	—	—	—	—	—	—	—	YT 2515	33
	—	—	—	—	—	—	—	—	YT 2520	45
—	—	—	—	—	—	—	—	YT 2525	57	
26	TA 2616 Z	30.5	TAM 2616	34.5	—	—	—	—	—	—
	TA 2620 Z	38	TAM 2620	42.5	—	—	—	—	—	—
	—	—	—	—	—	—	—	—	YT 2616	37
	—	—	—	—	—	—	—	—	YT 2620	46.5
28	—	—	—	—	TLA 2816 Z	28.5	TLAM 2816	33.5	—	—
	—	—	—	—	TLA 2820 Z	35.5	TLAM 2820	40.5	—	—
	TA 2820 Z	45	TAM 2820	50	—	—	—	—	—	—
	TA 2830 Z	67.5	TAM 2830	72.5	—	—	—	—	—	—
	—	—	—	—	—	—	—	—	YT 2820	56.5
	—	—	—	—	—	—	—	—	—	—

主要尺寸 mm				标准安装尺寸 mm						基本额定 动负荷 C	基本额定 静负荷 C ₀	容 许 ⁽¹⁾ 转 速	搭配的内圈
F _w	D	C	t ₁ 最大	轴径 h6		轴承座直径				N	N	min ⁻¹	
				最大	最小	J7		N7					
25	32	12	2.8							9 440	13 900	15 000	—
25	32	16	2.8							12 800	20 500	15 000	—
25	32	20	2.8							16 900	29 300	15 000	IRT 2020-1
25	32	26	2.8	25.000	24.987	—	—	31.992	31.967	22 600	42 500	15 000	IRT 2026-1
25	32	38	2.8							28 900	58 500	15 000	IRT 2038-1
25	32	26	—							35 000	75 800	6 000	IRT 2026-1
25	33	10	3.4							7 990	9 900	15 000	IRT 2010-1
25	33	15	3.4							13 400	19 300	15 000	IRT 2015-1
25	33	20	3.4	25.000	24.987	33.014	32.989	—	—	19 500	31 100	15 000	IRT 2020-1
25	33	25	3.4							24 100	40 800	15 000	IRT 2025-1
25	33	30	3.4							29 100	52 000	15 000	IRT 2030-1
25	33	10	—							15 500	23 600	6 000	IRT 2010-1
25	33	15	—							22 700	38 300	6 000	IRT 2015-1
25	33	20	—	25.000	24.987	33.014	32.989	—	—	30 200	55 400	6 000	IRT 2020-1
25	33	25	—							37 200	72 500	6 000	IRT 2025-1
26	34	16	3.4							15 200	22 900	15 000	IRT 2216
26	34	20	3.4	26.000	25.987	34.014	33.989	—	—	20 100	32 800	15 000	IRT 2220
26	34	16	—							24 700	43 300	6 000	IRT 2216
26	34	20	—							30 800	57 500	6 000	IRT 2220
28	35	16	2.8	28.000	27.987	—	—	34.992	34.967	13 800	23 500	13 000	—
28	35	20	2.8							18 300	33 600	13 000	IRT 2220-1
28	37	20	3.4							21 200	32 300	13 000	IRT 2220-1
28	37	30	3.4	28.000	27.987	37.014	36.989	—	—	33 000	56 900	13 000	IRT 2230-1
28	37	20	—							34 700	61 700	5 500	IRT 2220-1

1N≈0.102kgf

注(1) 容许转速适用于润滑油润滑。润滑脂润滑的话可容许到该值的60%。

备注1. 公称型号中的“W”表示滚动体为双列。

2. 润滑脂固定满滚子冲压外圈型滚针轴承已封入润滑脂。标准型及一端密闭型未封入润滑脂，请适当润滑后使用。

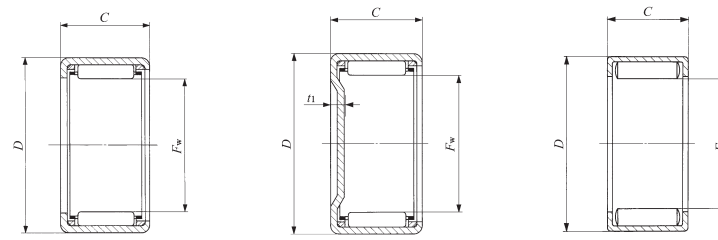

TA...Z TLA...Z

TAM TLAM

YT

轴径29-35mm

轴径 mm	公称型号									
	标准型	质量 (参考) g	一端密封型	质量 (参考) g	标准型	质量 (参考) g	一端密封型	质量 (参考) g	润滑脂固定	质量 (参考) g
29	TA 2920 Z	47	TAM 2920	52	—	—	—	—	—	—
	TA 2930 Z	70	TAM 2930	75.5	—	—	—	—	—	—
	—	—	—	—	—	—	—	—	YT 2920	58.5
30	—	—	—	—	TLA 3012 Z	23.5	TLAM 3012	29	—	—
	—	—	—	—	TLA 3016 Z	30.5	TLAM 3016	36	—	—
	—	—	—	—	TLA 3018 Z	34.5	TLAM 3018	40	—	—
	—	—	—	—	TLA 3020 Z	38	TLAM 3020	43.5	—	—
	—	—	—	—	TLA 3026 Z	49	TLAM 3026	54.5	—	—
	—	—	—	—	TLAW3038 Z	69	TLAMW3038	74.5	—	—
	TA 3013 Z	36.5	TAM 3013	42.5	—	—	—	—	—	—
	TA 3015 Z	42	TAM 3015	47.5	—	—	—	—	—	—
	TA 3020 Z	54.5	TAM 3020	60	—	—	—	—	—	—
	TA 3025 Z	68	TAM 3025	73.5	—	—	—	—	—	—
TA 3030 Z	80	TAM 3030	85.5	—	—	—	—	—	—	
32	TA 3220 Z	57.5	TAM 3220	63.5	—	—	—	—	—	—
	TA 3230 Z	86	TAM 3230	97.5	—	—	—	—	—	—
	—	—	—	—	—	—	—	—	YT 3220	71.5
35	—	—	—	—	TLA 3512 Z	27	TLAM 3512	34.5	—	—
	—	—	—	—	TLA 3516 Z	35	TLAM 3516	42.5	—	—
	—	—	—	—	TLA 3520 Z	43.5	TLAM 3520	51	—	—
	TA 3512 Z	38.5	TAM 3512	46	—	—	—	—	—	—
	TA 3515 Z	48	TAM 3515	56	—	—	—	—	—	—
	TA 3520 Z	62.5	TAM 3520	70	—	—	—	—	—	—
	TA 3525 Z	78	TAM 3525	85.5	—	—	—	—	—	—
TA 3530 Z	97	TAM 3530	105	—	—	—	—	—	—	

主要尺寸 mm				标准安装尺寸 mm				基本额定 动负荷 C	基本额定 静负荷 C ₀	容 许 ⁽¹⁾ 转 速 min ⁻¹	搭配的内圈		
F _w	D	C	t ₁ 最大	轴径 h6		轴承座直径							
				最大	最小	最大 J7	最小	最大 N7	最小				
29	38	20	3.4	29.000	28.987	38.014	37.989	—	—	22 000	34 200	13 000	IRT 2520
29	38	30	3.4	—	—	—	—	—	—	34 200	60 300	13 000	IRT 2530
29	38	20	—	—	—	—	—	—	—	35 500	64 100	5 000	IRT 2520
30	37	12	2.8	—	—	—	—	—	—	10 400	16 600	12 000	—
30	37	16	2.8	—	—	—	—	—	—	14 100	24 500	12 000	—
30	37	18	2.8	30.000	29.987	—	—	36.992	36.967	16 400	29 800	12 000	—
30	37	20	2.8	—	—	—	—	—	—	18 600	35 100	12 000	IRT 2520-1
30	37	26	2.8	—	—	—	—	—	—	24 800	50 900	12 000	IRT 2526-1
30	37	38	2.8	—	—	—	—	—	—	31 900	70 200	12 000	IRT 2538-1
30	40	13	3.4	—	—	—	—	—	—	13 500	16 800	12 000	—
30	40	15	3.4	—	—	—	—	—	—	16 800	22 400	12 000	IRT 2515-1
30	40	20	3.4	30.000	29.987	40.014	39.989	—	—	24 500	36 300	12 000	IRT 2520-1
30	40	25	3.4	—	—	—	—	—	—	31 600	50 300	12 000	IRT 2525-1
30	40	30	3.4	—	—	—	—	—	—	36 700	60 700	12 000	IRT 2530-1
32	42	20	3.4	—	—	—	—	—	—	25 400	38 600	11 000	IRT 2820
32	42	30	3.4	32.000	31.984	42.014	41.989	—	—	39 500	68 400	11 000	IRT 2830
32	42	20	—	—	—	—	—	—	—	39 900	70 100	4 500	IRT 2820
35	42	12	2.8	—	—	—	—	—	—	11 600	20 000	10 000	IRT 3012
35	42	16	2.8	35.000	34.984	—	—	41.992	41.967	15 700	29 600	10 000	—
35	42	20	2.8	—	—	—	—	—	—	20 700	42 300	10 000	IRT 3020
35	45	12	3.4	—	—	—	—	—	—	14 800	19 900	10 000	IRT 3012
35	45	15	3.4	—	—	—	—	—	—	18 500	26 500	10 000	IRT 3015
35	45	20	3.4	35.000	34.984	45.014	44.989	—	—	27 000	43 100	10 000	IRT 3020
35	45	25	3.4	—	—	—	—	—	—	34 800	59 700	10 000	IRT 3025
35	45	30	3.4	—	—	—	—	—	—	40 600	72 600	10 000	IRT 3030

注(1) 容许转速适用于润滑油润滑。润滑脂润滑的话可容许到该值的60%。

备注1. 公称型号中的“W”表示滚动体为双列。

2. 润滑脂固定满滚子冲压外圈型滚针轴承已封入润滑脂。标准型及一端密封型未封入润滑脂，请适当润滑后使用。

1N=0.102kgf

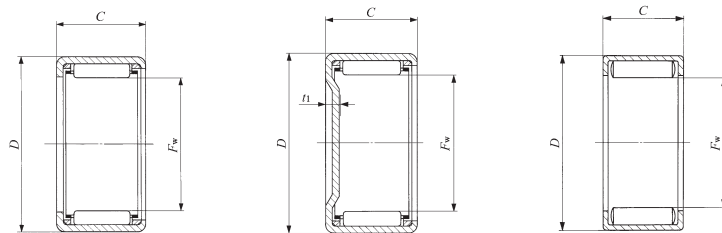

TA...Z TLA...Z

TAM TLAM

YT

轴径37-45mm

轴径 mm	公称型号									
	标准型	质量 (参考) g	一端密闭型	质量 (参考) g	标准型	质量 (参考) g	一端密闭型	质量 (参考) g	润滑脂固定	质量 (参考) g
37	TA 3720 Z	64.5	TAM 3720	73	—	—	—	—	—	—
	TA 3730 Z	101	TAM 3730	110	—	—	—	—	—	—
	—	—	—	—	—	—	—	—	YT 3720	81
38	TA 3815 Z	51	TAM 3815	60	—	—	—	—	—	—
	TA 3820 Z	65.5	TAM 3820	74.5	—	—	—	—	—	—
	TA 3825 Z	82.5	TAM 3825	96	—	—	—	—	—	—
	TA 3830 Z	104	TAM 3830	114	—	—	—	—	—	—
	TAW 3845 Z	149	TAMW 3845	159	—	—	—	—	—	—
40	—	—	—	—	TLA 4012 Z	30	TLAM 4012	40	—	—
	—	—	—	—	TLA 4016 Z	39	TLAM 4016	49	—	—
	—	—	—	—	TLA 4020 Z	49	TLAM 4020	58.5	—	—
	TA 4015 Z	54	TAM 4015	63.5	—	—	—	—	—	—
	TA 4020 Z	69.5	TAM 4020	79	—	—	—	—	—	—
	TA 4025 Z	86.5	TAM 4025	102	—	—	—	—	—	—
	TA 4030 Z	110	TAM 4030	120	—	—	—	—	—	—
	TA 4040 Z	144	TAM 4040	154	—	—	—	—	—	—
	—	—	—	—	—	—	—	—	YT 4015	63.5
	—	—	—	—	—	—	—	—	YT 4025	109
	45	—	—	—	—	TLA 4516 Z	43.5	TLAM 4516	56	—
—		—	—	—	TLA 4520 Z	54.5	TLAM 4520	67	—	—
TA 4520 Z		77	TAM 4520	90	—	—	—	—	—	—
TA 4525 Z		102	TAM 4525	115	—	—	—	—	—	—
TA 4530 Z		122	TAM 4530	135	—	—	—	—	—	—
TA 4540 Z		161	TAM 4540	174	—	—	—	—	—	—
—		—	—	—	—	—	—	—	—	—
—		—	—	—	—	—	—	—	YT 4520	96
—		—	—	—	—	—	—	—	YT 4525	122

主要尺寸 mm				标准安装尺寸 mm				基本额定 动负荷 C	基本额定 静负荷 C ₀	容 许 ⁽¹⁾ 转 速 min ⁻¹	搭配的内圈		
F _w	D	C	t ₁ 最大	轴径 h6		轴承座直径							
				最大	最小	最大	最小	N	N				
37	47	20	3.4	37.000	36.984	47.014	46.989	—	—	27 800	45 400	9 500	IRT 3220
37	47	30	3.4	—	—	—	—	—	—	41 800	76 700	9 500	IRT 3230
37	47	20	—	—	—	—	—	—	—	43 300	81 300	4 000	IRT 3220
38	48	15	3.4	—	—	—	—	—	—	19 000	28 000	9 000	IRT 3215-1
38	48	20	3.4	—	—	—	—	—	—	27 700	45 600	9 000	IRT 3220-1
38	48	25	3.4	38.000	37.984	48.014	47.989	—	—	35 600	63 100	9 000	IRT 3225-1
38	48	30	3.4	—	—	—	—	—	—	43 100	80 600	9 000	IRT 3230-1
38	48	45	3.4	—	—	—	—	—	—	55 700	112 000	9 000	IRT 3245-1
40	47	12	2.8	—	—	—	—	—	—	12 400	22 800	8 500	—
40	47	16	2.8	40.000	39.984	—	—	46.992	46.967	16 700	33 700	8 500	—
40	47	20	2.8	—	—	—	—	—	—	22 100	48 200	8 500	IRT 3520
40	50	15	3.4	—	—	—	—	—	—	19 500	29 400	8 500	IRT 3515
40	50	20	3.4	—	—	—	—	—	—	28 400	47 800	8 500	IRT 3520
40	50	25	3.4	—	—	—	—	—	—	36 600	66 200	8 500	IRT 3525
40	50	30	3.4	40.000	39.984	50.014	49.989	—	—	44 300	84 600	8 500	IRT 3530
40	50	40	3.4	—	—	—	—	—	—	56 700	116 000	8 500	IRT 3540
40	50	15	—	—	—	—	—	—	—	33 400	59 800	4 000	IRT 3515
40	50	25	—	—	—	—	—	—	—	55 300	114 000	4 000	IRT 3525
45	52	16	2.8	—	—	—	—	—	—	17 800	37 800	7 500	—
45	52	20	2.8	45.000	44.984	—	—	51.991	51.961	23 400	54 000	7 500	IRT 4020
45	55	20	3.4	—	—	—	—	—	—	30 600	54 600	7 500	IRT 4020
45	55	25	3.4	—	—	—	—	—	—	39 400	75 600	7 500	IRT 4025
45	55	30	3.4	45.000	44.984	55.018	54.988	—	—	47 700	96 600	7 500	IRT 4030
45	55	40	3.4	—	—	—	—	—	—	61 300	133 000	7 500	IRT 4040
45	55	20	—	—	—	—	—	—	—	47 800	98 200	3 500	IRT 4020
45	55	25	—	—	—	—	—	—	—	59 100	129 000	3 500	IRT 4025

注(1) 容许转速适用于润滑油润滑。润滑脂润滑的话可容许到该值的60%。

备注1. 公称型号中的“W”表示滚动体为双列。

2. 润滑脂固定满滚子冲压外圈型滚针轴承已封入润滑脂。标准型及一端密闭型未封入润滑脂，请适当润滑后使用。

1N=0.102kgf

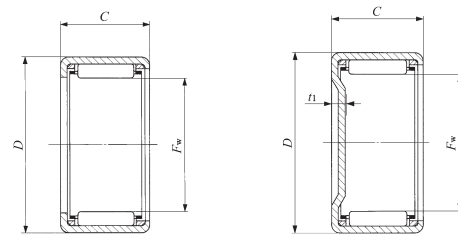
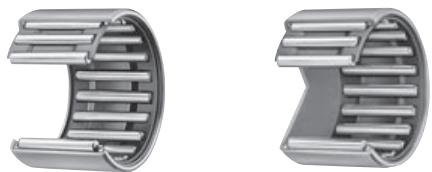

TA...Z TLA...Z

TAM TLAM

轴径50-62mm

轴径 mm	公称型号									
	标准型	质量 (参考) g	一端密闭型	质量 (参考) g	标准型	质量 (参考) g	一端密闭型	质量 (参考) g	润滑脂固定	质量 (参考) g
50	—	—	—	—	TLA 5020 Z	69	TLAM 5020	84.5	—	—
	—	—	—	—	TLA 5025 Z	86	TLAM 5025	107	—	—
	TA 5012 Z	62.5	TAM 5012	78	—	—	—	—	—	—
	TA 5015 Z	78	TAM 5015	98.5	—	—	—	—	—	—
	TA 5020 Z	107	TAM 5020	123	—	—	—	—	—	—
	TA 5025 Z	134	TAM 5025	150	—	—	—	—	—	—
	TA 5030 Z	161	TAM 5030	178	—	—	—	—	—	—
	TA 5040 Z	210	TAM 5040	230	—	—	—	—	—	—
TAW 5045 Z	230	TAMW 5045	245	—	—	—	—	—	—	
55	—	—	—	—	TLA 5520 Z	75	TLAM 5520	98.5	—	—
	—	—	—	—	TLA 5525 Z	98.5	TLAM 5525	118	—	—
	TA 5520 Z	116	TAM 5520	136	—	—	—	—	—	—
	TA 5525 Z	145	TAM 5525	165	—	—	—	—	—	—
	TA 5530 Z	175	TAM 5530	195	—	—	—	—	—	—
	TA 5540 Z	230	TAM 5540	250	—	—	—	—	—	—
	TAW 5545 Z	250	TAMW 5545	270	—	—	—	—	—	—
	TAW 5550 Z	280	TAMW 5550	300	—	—	—	—	—	—
60	TA 6025 Z	158	TAM 6025	182	—	—	—	—	—	—
	TA 6030 Z	191	TAM 6030	215	—	—	—	—	—	—
	TA 6040 Z	250	TAM 6040	275	—	—	—	—	—	—
	TAW 6045 Z	270	TAMW 6045	295	—	—	—	—	—	—
	TAW 6050 Z	305	TAMW 6050	330	—	—	—	—	—	—
62	TA 6212 Z	78	TAM 6212	107	—	—	—	—	—	

主要尺寸 mm				标准安装尺寸 mm				基本额定 动负荷 C	基本额定 静负荷 C ₀	容 许 ⁽¹⁾ 转 速 min ⁻¹	搭配的内圈				
F _w	D	C	t ₁ 最大	轴径 h6		轴承座直径									
				最大	最小	最大 J7	最小	最大 N7	最小						
50	58	20	2.8	50.000	49.984	—	—	28 800	64 100	6 500	IRT 4520				
50	58	25	2.8									57.991	57.961	36 900	88 400
50	62	12	3.4	50.000	49.984	62.018	61.988	—	—	—	—				
50	62	15	3.4									17 700	24 000	6 500	IRT 4512
50	62	20	3.4									25 800	39 000	6 500	IRT 4515
50	62	20	3.4									38 000	64 000	6 500	IRT 4520
50	62	25	3.4									49 100	89 000	6 500	IRT 4525
50	62	30	3.4									59 500	114 000	6 500	IRT 4530
50	62	40	3.4									76 500	157 000	6 500	IRT 4540
50	62	45	3.4									76 700	158 000	6 500	IRT 4545
55	63	20	2.8	55.000	54.981	—	—	29 800	69 400	5 500	IRT 5020-1				
55	63	25	2.8									62.991	62.961	38 300	95 700
55	67	20	3.4	55.000	54.981	67.018	66.988	—	—	—	—				
55	67	25	3.4									39 600	69 700	5 500	IRT 5020-1
55	67	30	3.4									51 200	97 000	5 500	IRT 5025-1
55	67	30	3.4									62 000	124 000	5 500	IRT 5030-1
55	67	40	3.4									80 000	172 000	5 500	IRT 5040-1
55	67	45	3.4									79 900	172 000	5 500	IRT 5045-1
55	67	50	3.4									91 500	205 000	5 500	IRT 5050-1
60	72	25	3.4									60.000	59.981	72.018	71.988
60	72	30	3.4	54 700	108 000	5 000	IRT 5025								
60	72	30	3.4	66 300	139 000	5 000	IRT 5030								
60	72	40	3.4	85 700	193 000	5 000	IRT 5040								
60	72	45	3.4	85 400	193 000	5 000	IRT 5045								
60	72	50	3.4	97 800	229 000	5 000	IRT 5050								
62	74	12	3.4	62.000	61.981	74.018	73.988	—	—	20 100	30 300	4 500	IRT 5212		

注(1) 容许转速适用于润滑油润滑。润滑脂润滑的话可容许到该值的60%。

备注1. 公称型号中的“W”表示滚动体为双列。

2. 润滑脂固定满滚子冲压外圈型滚针轴承已封入润滑脂。标准型及一端密闭型未封入润滑脂，请适当润滑后使用。

1N=0.102kgf

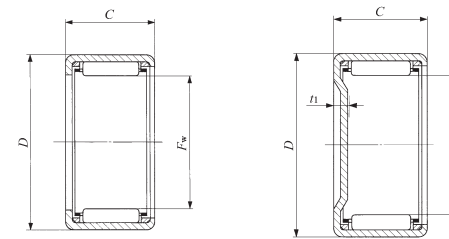
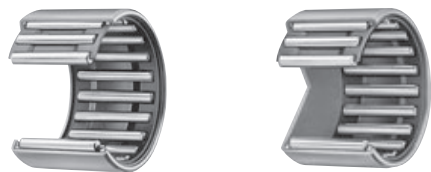

TA...Z

TAM

轴径65 - 70mm

轴径 mm	公称型号									
	标准型	质量 (参考) g	一端密闭型	质量 (参考) g	标准型	质量 (参考) g	一端密闭型	质量 (参考) g	润滑脂固定	质量 (参考) g
65	TA 6525 Z	169	TAM 6525	197	—	—	—	—	—	—
	TA 6530 Z	205	TAM 6530	230	—	—	—	—	—	—
	TAW 6545 Z	290	TAMW 6545	315	—	—	—	—	—	—
	TAW 6550 Z	330	TAMW 6550	355	—	—	—	—	—	—
70	TA 7025 Z	181	TAM 7025	215	—	—	—	—	—	—
	TA 7030 Z	220	TAM 7030	250	—	—	—	—	—	—
	TA 7040 Z	290	TAM 7040	320	—	—	—	—	—	—
	TAW 7050 Z	350	TAMW 7050	380	—	—	—	—	—	—

主要尺寸 mm				标准安装尺寸 mm						基本额定 动负荷 C	基本额定 静负荷 C ₀	容 许 ⁽¹⁾ 转 速	搭配的内圈
F _w	D	C	t ₁ 最大	轴径 h6		轴承座直径				N	N	min ⁻¹	
				最大	最小	J7		N7					
65	77	25	3.4	65.000	64.981	77.018	76.988	—	—	56 500	116 000	4 000	IRT 5525
65	77	30	3.4							68 500	149 000	4 000	IRT 5530
65	77	45	3.4							88 300	207 000	4 000	IRT 5545
65	77	50	3.4							101 000	246 000	4 000	IRT 5550
70	82	25	3.4	70.000	69.981	82.022	81.987	—	—	58 500	124 000	3 500	IRT 6025
70	82	30	3.4							70 900	159 000	3 500	IRT 6030
70	82	40	3.4							92 000	222 000	3 500	IRT 6040
70	82	50	3.4							105 000	262 000	3 500	IRT 6050

1N=0.102kgf

注(1) 容许转速适用于润滑油润滑。润滑脂润滑的话可容许到该值的60%。

备注1. 公称型号中的“W”表示滚动体为双列。

2. 润滑脂固定满滚子冲压外圈型滚针轴承已封入润滑脂。标准型及一端密闭型未封入润滑脂，请适当润滑后使用。



轴径3.969 - 9.525mm

轴径 mm (inch)	公称型号									
	标准型	质量 (参考) g	一端密闭型	质量 (参考) g	标准型	质量 (参考) g	一端密闭型	质量 (参考) g	润滑脂固定	质量 (参考) g
3.969 (5/32)	—	—	—	—	—	—	—	—	YB 2.5 2.5	0.64
	—	—	—	—	—	—	—	—	YB 2.5 4	0.96
4.762 (3/16)	—	—	—	—	—	—	—	—	YB 34	1.6
6.350 (1/4)	BA 44	2.1	—	—	—	—	—	—	—	—
	BA 45 Z	2.5	BAM 45	2.7	—	—	—	—	—	—
	BA 47 Z	3.5	BAM 47	3.7	—	—	—	—	—	—
	—	—	—	—	—	—	—	—	YB 45	3.2
	—	—	—	—	—	—	—	—	YB 47	4.6
7.938 (5/16)	BA 55 Z	3	BAM 55	3.3	—	—	—	—	—	—
	BA 56 Z	3.6	BAM 56	3.9	—	—	—	—	—	—
	BA 57 Z	4.3	BAM 57	4.6	—	—	—	—	—	—
	BA 59 Z	5.4	BAM 59	5.7	—	—	—	—	—	—
	—	—	—	—	—	—	—	—	YB 55	3.8
—	—	—	—	BHA 57 Z	6.3	BHAM 57	6.6	—	—	—
9.525 (3/8)	BA 65 Z	3.5	BAM 65	3.9	—	—	—	—	—	—
	BA 66 Z	4.2	BAM 66	4.6	—	—	—	—	—	—
	BA 68 Z	5.7	BAM 68	6.1	—	—	—	—	—	—
	BA 69 Z	6.3	BAM 69	6.7	—	—	—	—	—	—
	BA 610 Z	7	BAM 610	7.4	—	—	—	—	—	—
	—	—	—	—	—	—	—	—	YB 64	3.4
	—	—	—	—	—	—	—	—	YB 66	5.3
	—	—	—	—	—	—	—	—	YB 68	7.2
	—	—	—	—	—	—	—	—	YB 610	9.1
	—	—	—	—	BHA 68 Z	8.2	BHAM 68	8.6	—	—

注(1) 容许转速适用于润滑油润滑。润滑脂润滑的话可容许到该值的60%。

备注 润滑脂固定满滚子冲压外圈型滚针轴承已封入润滑脂。标准型及一端密闭型未封入润滑脂，请适当润滑后使用。

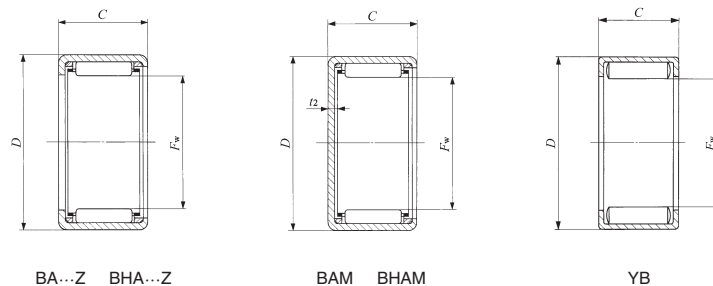

主要尺寸 mm(inch)				标准安装尺寸 mm				基本额定 动负荷 C	基本额定 静负荷 C ₀	容 许 ⁽¹⁾ 转 速	搭配的内圈
F _w	D	C	t ₂ 最大	轴径 h6		轴承座直径 J7					
				最大	最小	最大	最小	N	N	min ⁻¹	
3.969 ^(5/32)	7.144 ^(9/32)	3.96(.156)	—	3.969	3.961	7.152	7.137	1 350	1 220	40 000	—
3.969 ^(5/32)	7.144 ^(9/32)	6.35(.250)	—	—	—	—	—	2 320	2 440	40 000	—
4.762 ^(3/16)	8.731 ^(11/32)	6.35(.250)	—	4.762	4.754	8.739	8.724	2 770	2 700	30 000	—
6.350 ^(1/4)	11.112 ^(7/16)	6.35(.250)	1	—	—	—	—	1 770	1 390	55 000	—
6.350 ^(1/4)	11.112 ^(7/16)	7.92(.312)	1	—	—	—	—	1 510	1 120	55 000	—
6.350 ^(1/4)	11.112 ^(7/16)	11.13(.438)	1	6.350	6.341	11.122	11.104	2 650	2 310	55 000	—
6.350 ^(1/4)	11.112 ^(7/16)	7.92(.312)	—	—	—	—	—	4 450	4 870	25 000	—
6.350 ^(1/4)	11.112 ^(7/16)	11.13(.438)	—	—	—	—	—	6 320	7 650	25 000	—
7.938 ^(5/16)	12.700 ^(1/2)	7.92(.312)	1	—	—	—	—	1 880	1 560	45 000	—
7.938 ^(5/16)	12.700 ^(1/2)	9.52(.375)	1	—	—	—	—	2 620	2 390	45 000	—
7.938 ^(5/16)	12.700 ^(1/2)	11.13(.438)	1	7.938	7.929	12.710	12.692	3 310	3 220	45 000	—
7.938 ^(5/16)	12.700 ^(1/2)	14.27(.562)	1	—	—	—	—	4 190	4 360	45 000	—
7.938 ^(5/16)	12.700 ^(1/2)	7.92(.312)	—	—	—	—	—	5 110	6 090	20 000	—
7.938 ^(5/16)	14.288 ^(9/16)	11.13(.438)	1.3	7.938	7.929	14.298	14.280	4 150	3 730	45 000	—
9.525 ^(3/8)	14.288 ^(9/16)	7.92(.312)	1	—	—	—	—	2 220	2 010	40 000	—
9.525 ^(3/8)	14.288 ^(9/16)	9.52(.375)	1	—	—	—	—	3 090	3 080	40 000	—
9.525 ^(3/8)	14.288 ^(9/16)	12.70(.500)	1	9.525	9.516	14.298	14.280	4 190	4 560	40 000	—
9.525 ^(3/8)	14.288 ^(9/16)	14.27(.562)	1	—	—	—	—	4 940	5 630	40 000	—
9.525 ^(3/8)	14.288 ^(9/16)	15.88(.625)	1	—	—	—	—	5 660	6 700	40 000	—
9.525 ^(3/8)	14.288 ^(9/16)	6.35(.250)	—	—	—	—	—	4 470	5 360	16 000	—
9.525 ^(3/8)	14.288 ^(9/16)	9.52(.375)	—	9.525	9.516	14.298	14.280	6 920	9 410	16 000	—
9.525 ^(3/8)	14.288 ^(9/16)	12.70(.500)	—	—	—	—	—	9 210	13 600	16 000	—
9.525 ^(3/8)	14.288 ^(9/16)	15.88(.625)	—	—	—	—	—	11 300	17 800	16 000	—
9.525 ^(3/8)	15.875 ^(5/8)	12.70(.500)	1.3	9.525	9.516	15.885	15.867	4 880	4 740	40 000	—

1N=0.102kgf

英制系列



轴径11.112 - 12.700mm

轴径 mm (inch)	公称型号									
	标准型	质量 (参考) g	一端密封型	质量 (参考) g	标准型	质量 (参考) g	一端密封型	质量 (参考) g	润滑脂固定	质量 (参考) g
11.112 (⁷ / ₁₆)	BA 76 Z	4.8	BAM 76	5.3	—	—	—	—	—	—
	BA 77 Z	5.6	BAM 77	6.2	—	—	—	—	—	—
	BA 78 Z	6.4	BAM 78	7	—	—	—	—	—	—
	BA 710 Z	7.9	BAM 710	8.5	—	—	—	—	—	—
	—	—	—	—	—	—	—	—	YB 78	8.2
	—	—	—	—	BHA 78 Z	9.3	BHAM 78	10	—	—
12.700 (¹ / ₂)	—	—	—	—	—	—	—	—	YB 78	10.5
	BA 85 Z	4.4	BAM 85	5.2	—	—	—	—	—	—
	BA 86 Z	5.3	BAM 86	6.1	—	—	—	—	—	—
	BA 87 Z	6.3	BAM 87	7	—	—	—	—	—	—
	BA 88 Z	7.2	BAM 88	7.9	—	—	—	—	—	—
	BA 810 Z	8.9	BAM 810	9.6	—	—	—	—	—	—
	BA 812 Z	10.6	BAM 812	11.3	—	—	—	—	—	—
	—	—	—	—	—	—	—	—	YB 84	4.3
	—	—	—	—	—	—	—	—	YB 86	6.7
	—	—	—	—	—	—	—	—	YB 87	7.9
	—	—	—	—	—	—	—	—	YB 88	9.1
	—	—	—	—	—	—	—	—	YB 810	11.5
	—	—	—	—	—	—	—	—	YB 812	13.9
	—	—	—	—	BHA 87 Z	9.1	BHAM 87	9.9	—	—
	—	—	—	—	BHA 88 Z	10.4	BHAM 88	11.3	—	—
	—	—	—	—	BHA 810 Z	12.5	BHAM 810	13.3	—	—
	—	—	—	—	BHA 812 Z	15	BHAM 812	15.8	—	—
	—	—	—	—	—	—	—	—	YB 810	16

注(1) 容许转速适用于润滑油润滑。润滑脂润滑的话可容许到该值的60%。

备注 润滑脂固定满滚子冲压外圈型滚针轴承已封入润滑脂。标准型及一端密封型未封入润滑脂，请适当润滑后使用。

TA
TLA
BA
BHA

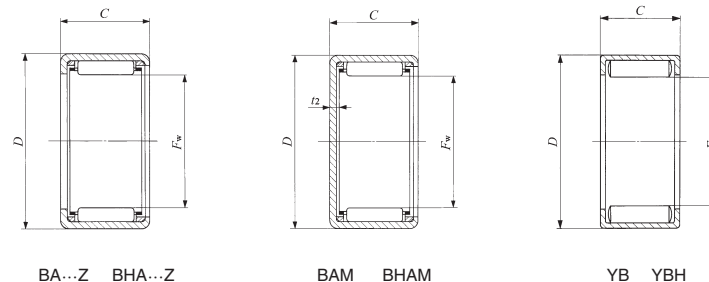

BA...Z BHA...Z

BAM BHAM

YB YBH

主要尺寸 mm(inch)				标准安装尺寸 mm				基本额定 动负荷 C	基本额定 静负荷 C ₀	容 许 ⁽¹⁾ 转 速	搭配的内圈
F _w	D	C	t ₂ 最大	轴径 h6		轴承座直径 J7					
				最大	最小	最大	最小	N	N	min ⁻¹	
11.112(⁷ / ₁₆)	15.875(⁵ / ₈)	9.52(.375)	1	11.112	11.101	15.885	15.867	3 290	3 470	35 000	—
11.112(⁷ / ₁₆)	15.875(⁵ / ₈)	11.13(.438)	1					4 150	4 680	35 000	—
11.112(⁷ / ₁₆)	15.875(⁵ / ₈)	12.70(.500)	1					4 460	5 130	35 000	—
11.112(⁷ / ₁₆)	15.875(⁵ / ₈)	15.88(.625)	1					6 020	7 550	35 000	—
11.112(⁷ / ₁₆)	15.875(⁵ / ₈)	12.70(.500)	—					10 100	15 900	14 000	—
11.112(⁷ / ₁₆)	17.462(¹¹ / ₁₆)	12.70(.500)	1.3					5 680	5 970	35 000	—
11.112(⁷ / ₁₆)	17.462(¹¹ / ₁₆)	12.70(.500)	—	12 500	15 800	14 000	—				
12.700(¹ / ₂)	17.462(¹¹ / ₁₆)	7.92(.312)	1	12.700	12.689	17.472	17.454	2 490	2 510	30 000	—
12.700(¹ / ₂)	17.462(¹¹ / ₁₆)	9.52(.375)	1					3 470	3 850	30 000	—
12.700(¹ / ₂)	17.462(¹¹ / ₁₆)	11.13(.438)	1					4 380	5 190	30 000	—
12.700(¹ / ₂)	17.462(¹¹ / ₁₆)	12.70(.500)	1					4 710	5 700	30 000	IRB 58
12.700(¹ / ₂)	17.462(¹¹ / ₁₆)	15.88(.625)	1					6 350	8 380	30 000	—
12.700(¹ / ₂)	17.462(¹¹ / ₁₆)	19.05(.750)	1					7 840	11 000	30 000	—
12.700(¹ / ₂)	17.462(¹¹ / ₁₆)	6.35(.250)	—	12.700	12.689	17.472	17.454	5 260	7 150	12 000	—
12.700(¹ / ₂)	17.462(¹¹ / ₁₆)	9.52(.375)	—					8 150	12 600	12 000	—
12.700(¹ / ₂)	17.462(¹¹ / ₁₆)	11.13(.438)	—					9 530	15 300	12 000	—
12.700(¹ / ₂)	17.462(¹¹ / ₁₆)	12.70(.500)	—					10 800	18 100	12 000	IRB 58
12.700(¹ / ₂)	17.462(¹¹ / ₁₆)	15.88(.625)	—					13 400	23 700	12 000	—
12.700(¹ / ₂)	17.462(¹¹ / ₁₆)	19.05(.750)	—					15 800	29 300	12 000	—
12.700(¹ / ₂)	19.050(³ / ₄)	11.13(.438)	1.3	12.700	12.689	19.062	19.041	5 670	6 120	30 000	—
12.700(¹ / ₂)	19.050(³ / ₄)	12.70(.500)	1.3					6 040	6 650	30 000	IRB 58
12.700(¹ / ₂)	19.050(³ / ₄)	15.88(.625)	1.3					8 830	10 900	30 000	—
12.700(¹ / ₂)	19.050(³ / ₄)	19.05(.750)	1.3					11 100	14 500	30 000	—
12.700(¹ / ₂)	19.050(³ / ₄)	15.88(.625)	—					16 300	23 500	12 000	—
12.700(¹ / ₂)	19.050(³ / ₄)	15.88(.625)	—					—	—	—	—

1N=0.102kgf

英制系列

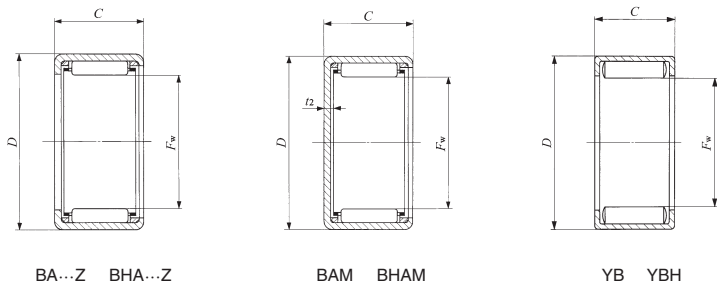

轴径14.288 – 15.875mm

轴径 mm (inch)	公称型号									
	标准型	质量 (参考) g	一端密封型	质量 (参考) g	标准型	质量 (参考) g	一端密封型	质量 (参考) g	润滑脂固定	质量 (参考) g
14.288 (⁹ / ₁₆)	BA 95 Z	4.9	BAM 95	5.8	—	—	—	—	—	—
	BA 96 Z	5.9	BAM 96	6.8	—	—	—	—	—	—
	BA 97 Z	6.9	BAM 97	7.8	—	—	—	—	—	—
	BA 98 Z	7.9	BAM 98	8.9	—	—	—	—	—	—
	BA 910 Z	9.9	BAM 910	10.8	—	—	—	—	—	—
	BA 912 Z	11.7	BAM 912	12.6	—	—	—	—	—	—
	—	—	—	—	—	—	—	—	YB 98	10.1
	—	—	—	—	—	—	—	—	YB 910	12.7
	—	—	—	—	—	—	—	—	YB 912	15.4
	—	—	—	—	BHA 98 Z	11.4	BHAM 98	12.5	—	—
—	—	—	—	BHA 910 Z	13.6	BHAM 910	14.7	—	—	
—	—	—	—	BHA 912 Z	16.3	BHAM 912	17.4	—	—	
15.875 (⁵ / ₈)	BA 105 Z	5.3	BAM 105	6.5	—	—	—	—	—	—
	BA 107 Z	7.6	BAM 107	8.7	—	—	—	—	—	—
	BA 108 Z	8.7	BAM 108	9.9	—	—	—	—	—	—
	BA 1010 Z	10.8	BAM 1010	12	—	—	—	—	—	—
	BA 1012 Z	12.9	BAM 1012	14	—	—	—	—	—	—
	BA 1014 Z	15.1	BAM 1014	16.2	—	—	—	—	—	—
	BA 1016 Z	17.3	BAM 1016	18.4	—	—	—	—	—	—
	—	—	—	—	—	—	—	—	YB 105	6.7
	—	—	—	—	—	—	—	—	YB 108	11
	—	—	—	—	—	—	—	—	YB 1012	16.9
	—	—	—	—	BHA 108 Z	12.6	BHAM 108	13.9	—	—
	—	—	—	—	BHA 1010 Z	14.9	BHAM 1010	16.2	—	—
	—	—	—	—	BHA 1012 Z	18	BHAM 1012	19.3	—	—
	—	—	—	—	BHA 1016 Z	24	BHAM 1016	25	—	—
—	—	—	—	—	—	—	—	YBH 108	15.3	

注(1) 容许转速适用于润滑油润滑。润滑脂润滑的话可容许到该值的60%。

备注 润滑脂固定满滚子冲压外圈型滚针轴承已封入润滑脂。标准型及一端密封型未封入润滑脂，请适当润滑后使用。

主要尺寸 mm(inch)				标准安装尺寸 mm				基本额定 动负荷 C	基本额定 静负荷 C ₀	容 许 ⁽¹⁾ 转 速	搭配的内圈				
F _w	D	C	t ₂ 最大	轴径 h6		轴承座直径 J7									
				最大	最小	最大	最小	N	N	min ⁻¹					
14.288(⁹ / ₁₆)	19.050(³ / ₄)	7.92(.312)	1.3	14.288	14.277	19.062	19.041	2 760	2 970	30 000	—				
14.288(⁹ / ₁₆)	19.050(³ / ₄)	9.52(.375)	1.3					3 850	4 560	30 000	—				
14.288(⁹ / ₁₆)	19.050(³ / ₄)	11.13(.438)	1.3					4 860	6 140	30 000	—				
14.288(⁹ / ₁₆)	19.050(³ / ₄)	12.70(.500)	1.3					5 220	6 740	30 000	IRB 68				
14.288(⁹ / ₁₆)	19.050(³ / ₄)	15.88(.625)	1.3					7 050	9 910	30 000	—				
14.288(⁹ / ₁₆)	19.050(³ / ₄)	19.05(.750)	1.3					8 690	13 000	30 000	IRB 612				
14.288(⁹ / ₁₆)	19.050(³ / ₄)	12.70(.500)	—					11 600	20 400	11 000	IRB 68				
14.288(⁹ / ₁₆)	19.050(³ / ₄)	15.88(.625)	—					14 300	26 700	11 000	—				
14.288(⁹ / ₁₆)	19.050(³ / ₄)	19.05(.750)	—					16 800	33 000	11 000	IRB 612				
14.288(⁹ / ₁₆)	20.638(¹³ / ₁₆)	12.70(.500)	1.3					14.288	14.277	20.650	20.629	6 380	7 330	30 000	IRB 68
14.288(⁹ / ₁₆)	20.638(¹³ / ₁₆)	15.88(.625)	1.3	9 280	11 900	30 000	—								
14.288(⁹ / ₁₆)	20.638(¹³ / ₁₆)	19.05(.750)	1.3	11 600	15 900	30 000	IRB 612								
15.875(⁵ / ₈)	20.638(¹³ / ₁₆)	7.92(.312)	1.3	15.875	15.864	20.650	20.629	2 870	3 220	25 000	—				
15.875(⁵ / ₈)	20.638(¹³ / ₁₆)	11.13(.438)	1.3					5 040	6 660	25 000	—				
15.875(⁵ / ₈)	20.638(¹³ / ₁₆)	12.70(.500)	1.3					5 420	7 310	25 000	IRB 68-1				
15.875(⁵ / ₈)	20.638(¹³ / ₁₆)	15.88(.625)	1.3					7 320	10 700	25 000	—				
15.875(⁵ / ₈)	20.638(¹³ / ₁₆)	19.05(.750)	1.3					9 020	14 100	25 000	IRB 612-1				
15.875(⁵ / ₈)	20.638(¹³ / ₁₆)	22.22(.875)	1.3					10 700	17 500	25 000	IRB 714				
15.875(⁵ / ₈)	20.638(¹³ / ₁₆)	25.40(1.000)	1.3					12 300	20 800	25 000	IRB 716				
15.875(⁵ / ₈)	20.638(¹³ / ₁₆)	7.92(.312)	—					7 580	12 200	9 500	—				
15.875(⁵ / ₈)	20.638(¹³ / ₁₆)	12.70(.500)	—					12 300	22 700	9 500	IRB 68-1				
15.875(⁵ / ₈)	20.638(¹³ / ₁₆)	19.05(.750)	—					17 800	36 600	9 500	IRB 612-1				
15.875(⁵ / ₈)	22.225(⁷ / ₈)	12.70(.500)	1.3					15.875	15.864	22.237	22.216	6 680	8 020	25 000	IRB 68-1
15.875(⁵ / ₈)	22.225(⁷ / ₈)	15.88(.625)	1.3									10 200	13 800	25 000	—
15.875(⁵ / ₈)	22.225(⁷ / ₈)	19.05(.750)	1.3									12 700	18 500	25 000	IRB 612-1
15.875(⁵ / ₈)	22.225(⁷ / ₈)	25.40(1.000)	1.3									17 400	27 600	25 000	IRB 716
15.875(⁵ / ₈)	22.225(⁷ / ₈)	12.70(.500)	—	15 000	22 400	9 500	IRB 68-1								
15.875(⁵ / ₈)	22.225(⁷ / ₈)	—	—	—	—	—	—								

1N≈0.102kgf

英制系列

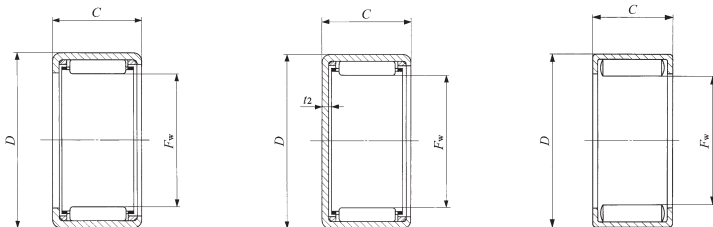

BA...Z BHA...Z

BAM BHAM

YB

轴径17.462 - 19.050mm

轴径 mm (inch)	公称型号									
	标准型	质量 (参考) g	一端密封型	质量 (参考) g	标准型	质量 (参考) g	一端密封型	质量 (参考) g	润滑脂固定	质量 (参考) g
17.462 (¹¹ / ₁₆)	BA 116 Z	7	BAM 116	8.4	—	—	—	—	—	—
	BA 118 Z	9.5	BAM 118	10.8	—	—	—	—	—	—
	BA 1110 Z	11.8	BAM 1110	13.2	—	—	—	—	—	—
	BA 1112 Z	14	BAM 1112	15.4	—	—	—	—	—	—
	—	—	—	—	—	—	—	—	YB 1112	18.3
	—	—	—	—	BHA 117 Z	11.9	BHAM 117	13.5	—	—
	—	—	—	—	BHA 118 Z	13.7	BHAM 118	15.3	—	—
	—	—	—	—	BHA 1110 Z	16	BHAM 1110	17.6	—	—
19.050 (³ / ₄)	—	—	—	—	BHA 1112 Z	19.3	BHAM 1112	21	—	—
	BA 126 Z	10	BAM 126	11.7	—	—	—	—	—	—
	BA 128 Z	13.5	BAM 128	15.2	—	—	—	—	—	—
	BA 1210 Z	17	BAM 1210	18.6	—	—	—	—	—	—
	BA 1212 Z	20.5	BAM 1212	22	—	—	—	—	—	—
	BA 1214 Z	23.5	BAM 1214	25	—	—	—	—	—	—
	BA 1216 Z	27	BAM 1216	28.5	—	—	—	—	—	—
	—	—	—	—	—	—	—	—	YB 124	8.5
	—	—	—	—	—	—	—	—	YB 128	17.8
	—	—	—	—	—	—	—	—	YB 1210	22.5
	—	—	—	—	—	—	—	—	YB 1212	27
	—	—	—	—	BHA 1212 Z	26.5	BHAM 1212	28.5	—	—

主要尺寸 mm(inch)				标准安装尺寸 mm				基本额定 动负荷 C	基本额定 静负荷 C ₀	容 许 ⁽¹⁾ 转 速 min ⁻¹	搭配的内圈
F _w	D	C	t ₂ 最大	轴径 h6		轴承座直径 J7					
				最大	最小	最大	最小	N	N		
17.462(¹¹ / ₁₆)	22.225(⁷ / ₈)	9.52(.375)	1.3					4 530	5 980	25 000	IRB 86
17.462(¹¹ / ₁₆)	22.225(⁷ / ₈)	12.70(.500)	1.3					6 140	8 850	25 000	IRB 88
17.462(¹¹ / ₁₆)	22.225(⁷ / ₈)	15.88(.625)	1.3	17.462	17.451	22.237	22.216	8 280	13 000	25 000	—
17.462(¹¹ / ₁₆)	22.225(⁷ / ₈)	19.05(.750)	1.3					10 200	17 000	25 000	IRB 812
17.462(¹¹ / ₁₆)	22.225(⁷ / ₈)	19.05(.750)	—					18 700	40 300	8 500	IRB 812
17.462(¹¹ / ₁₆)	23.812(¹⁵ / ₁₆)	11.13(.438)	1.3					6 860	8 530	25 000	—
17.462(¹¹ / ₁₆)	23.812(¹⁵ / ₁₆)	12.70(.500)	1.3	17.462	17.451	23.824	23.803	7 320	9 270	25 000	IRB 88
17.462(¹¹ / ₁₆)	23.812(¹⁵ / ₁₆)	15.88(.625)	1.3					10 500	14 900	25 000	—
17.462(¹¹ / ₁₆)	23.812(¹⁵ / ₁₆)	19.05(.750)	1.3					13 200	19 900	25 000	IRB 812
19.050(³ / ₄)	25.400(1)	9.52(.375)	1.3					5 040	5 850	20 000	—
19.050(³ / ₄)	25.400(1)	12.70(.500)	1.3					6 910	8 780	20 000	IRB 88-1
19.050(³ / ₄)	25.400(1)	15.88(.625)	1.3	19.050	19.037	25.412	25.391	9 500	13 200	20 000	IRB 810-1
19.050(³ / ₄)	25.400(1)	19.05(.750)	1.3					11 900	17 700	20 000	IRB 812-1
19.050(³ / ₄)	25.400(1)	22.22(.875)	1.3					14 200	22 200	20 000	IRB 814-1
19.050(³ / ₄)	25.400(1)	25.40(1.000)	1.3					16 300	26 500	20 000	IRB 816-1
19.050(³ / ₄)	25.400(1)	6.35(.250)	—					7 820	10 200	8 000	—
19.050(³ / ₄)	25.400(1)	12.70(.500)	—	19.050	19.037	25.412	25.391	16 600	26 900	8 000	IRB 88-1
19.050(³ / ₄)	25.400(1)	15.88(.625)	—					20 500	35 300	8 000	IRB 810-1
19.050(³ / ₄)	25.400(1)	19.05(.750)	—					24 100	43 400	8 000	IRB 812-1
19.050(³ / ₄)	26.988(1 ¹ / ₁₆)	19.05(.750)	1.3	19.050	19.037	27.000	26.979	16 600	22 600	20 000	IRB 812-1

注(1) 容许转速适用于润滑油润滑。润滑脂润滑的话可容许到该值的60%。
备注 润滑脂固定满滚子冲压外圈型滚针轴承已封入润滑脂。标准型及一端密封型未封入润滑脂，请适当润滑后使用。

1N=0.102kgf

英制系列

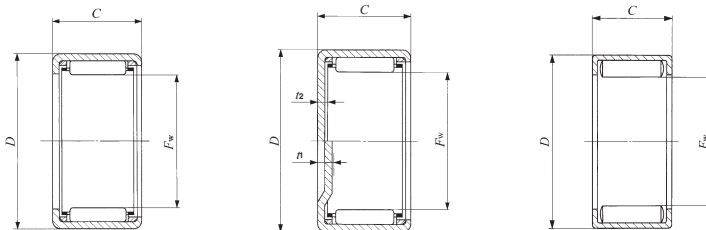

BA...Z BHA...Z

BAM BHAM
t₁ (F_w ≥ 22.225)
t₂ (F_w ≤ 20.638)

YB YBH

轴径20.638 - 22.225mm

轴径 mm (inch)	公称型号									
	标准型	质量 (参考) g	一端密闭型	质量 (参考) g	标准型	质量 (参考) g	一端密闭型	质量 (参考) g	润滑脂固定	质量 (参考) g
20.638 (13/16)	BA 136 Z	10.7	BAM 136	12.6	—	—	—	—	—	—
	BA 138 Z	14.5	BAM 138	16.4	—	—	—	—	—	—
	BA 1310 Z	18.2	BAM 1310	20	—	—	—	—	—	—
	BA 1312 Z	22	BAM 1312	23.5	—	—	—	—	—	—
	BA 1314 Z	25	BAM 1314	27	—	—	—	—	—	—
	BA 1316 Z	28.5	BAM 1316	30.5	—	—	—	—	—	—
	BA 1320 Z	35.5	BAM 1320	37.5	—	—	—	—	—	—
	—	—	—	—	—	—	—	—	YB 136	14.1
	—	—	—	—	—	—	—	—	YB 138	19.1
	—	—	—	—	BHA 138 Z	20	BHAM 138	22.5	—	—
—	—	—	—	BHA 1310 Z	23.5	BHAM 1310	25.5	—	—	
—	—	—	—	BHA 1312 Z	28.5	BHAM 1312	30.5	—	—	
—	—	—	—	—	—	—	—	YBH 1310	30.5	
—	—	—	—	—	—	—	—	YBH 1312	37	
22.225 (7/8)	BA 146 Z	11.5	BAM 146	13.8	—	—	—	—	—	—
	BA 148 Z	15.6	BAM 148	17.8	—	—	—	—	—	—
	BA 1412 Z	23.5	BAM 1412	26	—	—	—	—	—	—
	BA 1414 Z	27	BAM 1414	29.5	—	—	—	—	—	—
	BA 1416 Z	31	BAM 1416	33.5	—	—	—	—	—	—
	BA 1418 Z	34.5	BAM 1418	37	—	—	—	—	—	—
	BA 1422 Z	42.5	BAM 1422	44.5	—	—	—	—	—	—
	—	—	—	—	—	—	—	—	YB 148	20.5
	—	—	—	—	—	—	—	—	YB 1412	31
	—	—	—	—	—	—	—	—	YB 1416	41.5
—	—	—	—	BHA 1410 Z	25	BHAM 1410	27.5	—	—	
—	—	—	—	BHA 1412 Z	30	BHAM 1412	32.5	—	—	
—	—	—	—	BHA 1416 Z	39.5	BHAM 1416	42	—	—	
—	—	—	—	—	—	—	—	YBH 1412	39	

注(1) 容许转速适用于润滑油润滑。润滑脂润滑的话可容许到该值的60%。

备注 润滑脂固定滚针型冲压外圈型滚针轴承已封入润滑脂。标准型及一端密闭型未封入润滑脂，请适当润滑后使用。

主要尺寸 mm(inch)			标准安装尺寸 mm				基本额定 动负荷	基本额定 静负荷	容 许 ⁽¹⁾ 转 速	搭配的内圈	
F _w	D	C	t ₁ t ₂ 最大	轴径 h6		轴承座直径 J7		C	C ₀	min ⁻¹	
				最大	最小	最大	最小				
20.638 ^(13/16)	26.988 ^(1 1/16)	9.52 (.375)	1.3	—	—	—	—	5 230	6 300	19 000	—
20.638 ^(13/16)	26.988 ^(1 1/16)	12.70 (.500)	1.3	—	—	—	—	7 170	9 450	19 000	IRB 98
20.638 ^(13/16)	26.988 ^(1 1/16)	15.88 (.625)	1.3	—	—	—	—	9 870	14 200	19 000	IRB 910
20.638 ^(13/16)	26.988 ^(1 1/16)	19.05 (.750)	1.3	—	—	—	—	12 400	19 000	19 000	IRB 912
20.638 ^(13/16)	26.988 ^(1 1/16)	22.22 (.875)	1.3	20.638	20.625	27.000	26.979	14 700	23 800	19 000	IRB 914
20.638 ^(13/16)	26.988 ^(1 1/16)	25.40 (1.000)	1.3	—	—	—	—	16 900	28 500	19 000	IRB 916
20.638 ^(13/16)	26.988 ^(1 1/16)	31.75 (1.250)	1.3	—	—	—	—	21 200	38 100	19 000	IRB 920
20.638 ^(13/16)	26.988 ^(1 1/16)	9.52 (.375)	—	—	—	—	—	13 000	20 100	7 500	—
20.638 ^(13/16)	26.988 ^(1 1/16)	12.70 (.500)	—	—	—	—	—	17 400	29 200	7 500	IRB 98
20.638 ^(13/16)	28.575 ^(1 1/8)	12.70 (.500)	1.3	—	—	—	—	9 500	11 200	19 000	IRB 98
20.638 ^(13/16)	28.575 ^(1 1/8)	15.88 (.625)	1.3	—	—	—	—	13 800	18 200	19 000	IRB 910
20.638 ^(13/16)	28.575 ^(1 1/8)	19.05 (.750)	1.3	20.638	20.625	28.587	28.566	17 300	24 400	19 000	IRB 912
20.638 ^(13/16)	28.575 ^(1 1/8)	15.88 (.625)	—	—	—	—	—	22 900	36 300	7 500	IRB 910
20.638 ^(13/16)	28.575 ^(1 1/8)	19.05 (.750)	—	—	—	—	—	27 200	45 300	7 500	IRB 912
22.225 ^(7/8)	28.575 ^(1 1/8)	9.52 (.375)	2.8	—	—	—	—	5 430	6 740	18 000	IRB 106
22.225 ^(7/8)	28.575 ^(1 1/8)	12.70 (.500)	2.8	—	—	—	—	7 440	10 100	18 000	IRB 108
22.225 ^(7/8)	28.575 ^(1 1/8)	19.05 (.750)	2.8	—	—	—	—	12 800	20 400	18 000	IRB 1012
22.225 ^(7/8)	28.575 ^(1 1/8)	22.22 (.875)	2.8	—	—	—	—	15 300	25 500	18 000	IRB 1014
22.225 ^(7/8)	28.575 ^(1 1/8)	25.40 (1.000)	2.8	—	—	—	—	17 600	30 500	18 000	IRB 1016
22.225 ^(7/8)	28.575 ^(1 1/8)	28.58 (1.125)	2.8	22.225	22.212	28.587	28.566	19 800	35 600	18 000	—
22.225 ^(7/8)	28.575 ^(1 1/8)	34.92 (1.375)	2.8	—	—	—	—	24 100	45 700	18 000	IRB 1022
22.225 ^(7/8)	28.575 ^(1 1/8)	12.70 (.500)	—	—	—	—	—	18 100	31 400	7 000	IRB 108
22.225 ^(7/8)	28.575 ^(1 1/8)	19.05 (.750)	—	—	—	—	—	26 300	50 700	7 000	IRB 1012
22.225 ^(7/8)	28.575 ^(1 1/8)	25.40 (1.000)	—	—	—	—	—	33 800	70 200	7 000	IRB 1016
22.225 ^(7/8)	30.162 ^(1 1/16)	15.88 (.625)	3.4	—	—	—	—	14 300	19 500	18 000	—
22.225 ^(7/8)	30.162 ^(1 1/16)	19.05 (.750)	3.4	22.225	22.212	30.176	30.151	18 000	26 100	18 000	IRB 1012
22.225 ^(7/8)	30.162 ^(1 1/16)	25.40 (1.000)	3.4	—	—	—	—	23 600	36 900	18 000	IRB 1016
22.225 ^(7/8)	30.162 ^(1 1/16)	19.05 (.750)	—	—	—	—	—	28 200	49 000	7 000	IRB 1012

1N=0.102kgf

英制系列



轴径23.812 - 26.988mm

轴径 mm (inch)	公称型号									
	标准型	质量 (参考) g	一端密封型	质量 (参考) g	标准型	质量 (参考) g	一端密封型	质量 (参考) g	润滑脂固定	质量 (参考) g
23.812 (15/16)	BA 158 Z	16.5	BAM 158	19	—	—	—	—	—	—
	BA 1510 Z	20.5	BAM 1510	23	—	—	—	—	—	—
	BA 1516 Z	33	BAM 1516	35.5	—	—	—	—	—	—
25.400 (1)	BA 166 Z	13.1	BAM 166	16	—	—	—	—	—	—
	BA 167 Z	15.4	BAM 167	18.3	—	—	—	—	—	—
	BA 168 Z	17.7	BAM 168	20.5	—	—	—	—	—	—
	BA 1610 Z	22	BAM 1610	25	—	—	—	—	—	—
	BA 1612 Z	26.5	BAM 1612	29.5	—	—	—	—	—	—
	BA 1614 Z	31	BAM 1614	33.5	—	—	—	—	—	—
	BA 1616 Z	35.5	BAM 1616	38	—	—	—	—	—	—
	BA 1620 Z	44	BAM 1620	46.5	—	—	—	—	—	—
	—	—	—	—	—	—	—	—	YB 168	23
	—	—	—	—	—	—	—	—	YB 1612	34.5
	—	—	—	—	—	—	—	—	YB 1616	46.5
	—	—	—	—	BHA 168 Z	24	BHAM 168	27	—	—
	—	—	—	—	BHA 1610 Z	28	BHAM 1610	31	—	—
	—	—	—	—	BHA 1612 Z	33.5	BHAM 1612	37	—	—
	—	—	—	—	BHA 1614 Z	39.5	BHAM 1614	42.5	—	—
	—	—	—	—	BHA 1616 Z	45	BHAM 1616	48	—	—
	—	—	—	—	BHA 1620 Z	56.5	BHAM 1620	59.5	—	—
	—	—	—	—	BHA 1624 Z	67.5	BHAM 1624	71	—	—
	—	—	—	—	—	—	—	—	YBH 168	29
	—	—	—	—	—	—	—	—	YBH 1612	44.5
—	—	—	—	—	—	—	—	YBH 1616	59.5	
26.988 (1 1/16)	BA 1710 Z	23.5	BAM 1710	26.5	—	—	—	—	—	—
	BA 1716 Z	37	BAM 1716	40.5	—	—	—	—	—	—

注(1) 容许转速适用于润滑油润滑。润滑脂润滑的话可容许到该值的60%。

备注 润滑脂固定满滚子冲压外圈型滚针轴承已封入润滑脂。标准型及一端密封型未封入润滑脂，请适当润滑后使用。

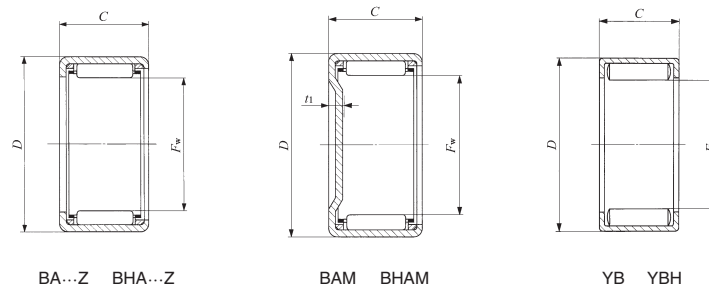

主要尺寸 mm(inch)				标准安装尺寸 mm				基本额定 动负荷 C	基本额定 静负荷 C ₀	容 许 ⁽¹⁾ 转 速 min ⁻¹	搭配的内圈
F _w	D	C	t ₁ 最大	轴径 h6 最大 最小	轴承座直径 J7 最大 最小	N	N				
23.812(15/16)	30.162(1 3/16)	12.70(.500)	2.8	23.812	23.799	30.176	30.151	8 000	11 400	16 000	—
23.812(15/16)	30.162(1 3/16)	15.88(.625)	2.8	—	—	—	—	11 000	17 100	16 000	IRB 1110
23.812(15/16)	30.162(1 3/16)	25.40(1.000)	2.8	—	—	—	—	18 900	34 300	16 000	IRB 1116
25.400(1)	31.750(1 3/4)	9.52(.375)	2.8	—	—	—	—	6 010	8 020	15 000	—
25.400(1)	31.750(1 3/4)	11.13(.438)	2.8	—	—	—	—	7 720	11 100	15 000	—
25.400(1)	31.750(1 3/4)	12.70(.500)	2.8	—	—	—	—	8 240	12 000	15 000	IRB 128
25.400(1)	31.750(1 3/4)	15.88(.625)	2.8	—	—	—	—	11 300	18 100	15 000	—
25.400(1)	31.750(1 3/4)	19.05(.750)	2.8	—	—	—	—	14 200	24 300	15 000	IRB 1212
25.400(1)	31.750(1 3/4)	22.22(.875)	2.8	25.400	25.387	31.764	31.739	16 900	30 400	15 000	IRB 1214
25.400(1)	31.750(1 3/4)	25.40(1.000)	2.8	—	—	—	—	19 400	36 300	15 000	IRB 1216
25.400(1)	31.750(1 3/4)	31.75(1.250)	2.8	—	—	—	—	24 400	48 500	15 000	IRB 1220
25.400(1)	31.750(1 3/4)	12.70(.500)	—	—	—	—	—	19 400	36 000	6 000	IRB 128
25.400(1)	31.750(1 3/4)	19.05(.750)	—	—	—	—	—	28 200	58 000	6 000	IRB 1212
25.400(1)	31.750(1 3/4)	25.40(1.000)	—	—	—	—	—	36 300	80 300	6 000	IRB 1216
25.400(1)	33.338(1 3/16)	12.70(.500)	3.4	—	—	—	—	10 200	13 100	15 000	IRB 128
25.400(1)	33.338(1 3/16)	15.88(.625)	3.4	—	—	—	—	15 300	22 100	15 000	—
25.400(1)	33.338(1 3/16)	19.05(.750)	3.4	—	—	—	—	19 300	29 700	15 000	IRB 1212
25.400(1)	33.338(1 3/16)	22.22(.875)	3.4	—	—	—	—	23 000	37 200	15 000	IRB 1214
25.400(1)	33.338(1 3/16)	25.40(1.000)	3.4	25.400	25.387	33.352	33.327	26 400	44 500	15 000	IRB 1216
25.400(1)	33.338(1 3/16)	31.75(1.250)	3.4	—	—	—	—	33 200	59 600	15 000	IRB 1220
25.400(1)	33.338(1 3/16)	38.10(1.500)	3.4	—	—	—	—	39 400	74 400	15 000	—
25.400(1)	33.338(1 3/16)	12.70(.500)	—	—	—	—	—	20 900	34 100	6 000	IRB 128
25.400(1)	33.338(1 3/16)	19.05(.750)	—	—	—	—	—	30 700	56 100	6 000	IRB 1212
25.400(1)	33.338(1 3/16)	25.40(1.000)	—	—	—	—	—	39 900	78 400	6 000	IRB 1216
26.988(1 1/16)	33.338(1 3/16)	15.88(.625)	2.8	26.988	26.975	33.352	33.327	11 600	19 200	14 000	—
26.988(1 1/16)	33.338(1 3/16)	25.40(1.000)	2.8	—	—	—	—	20 000	38 300	14 000	—

1N=0.102kgf

英制系列



轴径28.575 - 30.162mm

轴径 mm (inch)	公称型号									
	标准型	质量 (参考) g	一端密闭型	质量 (参考) g	标准型	质量 (参考) g	一端密闭型	质量 (参考) g	润滑脂固定	质量 (参考) g
28.575 (1 1/8)	BA 186 Z	14.5	BAM 186	18.1	—	—	—	—	—	—
	BA 188 Z	19.5	BAM 188	23	—	—	—	—	—	—
	BA 1812 Z	29.5	BAM 1812	33	—	—	—	—	—	—
	BA 1816 Z	39	BAM 1816	42.5	—	—	—	—	—	—
	BA 1820 Z	48.5	BAM 1820	52	—	—	—	—	—	—
	—	—	—	—	—	—	—	—	YB 188	25.5
	—	—	—	—	—	—	—	—	YB 1812	38.5
	—	—	—	—	—	—	—	—	YB 1816	51.5
	—	—	—	—	BHA 1812 Z	45	BHAM 1812	49	—	—
	—	—	—	—	BHA 1816 Z	60	BHAM 1816	64	—	—
—	—	—	—	BHA 1818 Z	67.5	BHAM 1818	71.5	—	—	
—	—	—	—	BHA 1820 Z	73.5	BHAM 1820	78	—	—	
30.162 (1 3/16)	BA 1910 Z	32.5	BAM 1910	37.5	—	—	—	—	—	—
	BA 1916 Z	52	BAM 1916	57	—	—	—	—	—	—
	—	—	—	—	—	—	—	—	YB 1910	42.5

注(1) 容许转速适用于润滑油润滑。润滑脂润滑的话可容许到该值的60%。

备注 润滑脂固定满滚子冲压外圈型滚针轴承已封入润滑脂。标准型及一端密闭型未封入润滑脂，请适当润滑后使用。

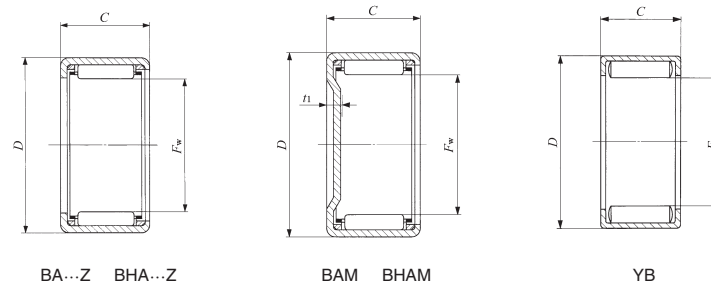

主要尺寸 mm(inch)				标准安装尺寸 mm				基本额定 动负荷 C	基本额定 静负荷 C ₀	容 许 ⁽¹⁾ 转 速 min ⁻¹	搭配的内圈
F _w	D	C	t ₁ 最大	轴径 h6		轴承座直径 J7					
				最大	最小	最大	最小	N	N	min ⁻¹	
28.575(1 1/8)	34.925(1 3/8)	9.52(.375)	2.8					6 330	8 910	13 000	—
28.575(1 1/8)	34.925(1 3/8)	12.70(.500)	2.8					8 680	13 400	13 000	IRB 148
28.575(1 1/8)	34.925(1 3/8)	19.05(.750)	2.8					15 000	26 900	13 000	IRB 1412
28.575(1 1/8)	34.925(1 3/8)	25.40(1.000)	2.8	28.575	28.562	34.939	34.914	20 500	40 300	13 000	IRB 1416
28.575(1 1/8)	34.925(1 3/8)	31.75(1.250)	2.8					25 700	53 900	13 000	IRB 1420
28.575(1 1/8)	34.925(1 3/8)	12.70(.500)	—					20 700	40 500	5 500	IRB 148
28.575(1 1/8)	34.925(1 3/8)	19.05(.750)	—					30 000	65 300	5 500	IRB 1412
28.575(1 1/8)	34.925(1 3/8)	25.40(1.000)	—					38 700	90 400	5 500	IRB 1416
28.575(1 1/8)	38.100(1 1/2)	19.05(.750)	3.4					22 500	32 200	13 000	IRB 1412
28.575(1 1/8)	38.100(1 1/2)	25.40(1.000)	3.4	28.575	28.562	38.114	38.089	30 900	48 600	13 000	IRB 1416
28.575(1 1/8)	38.100(1 1/2)	28.58(1.125)	3.4					34 900	56 600	13 000	—
28.575(1 1/8)	38.100(1 1/2)	31.75(1.250)	3.4					37 100	61 100	13 000	IRB 1420
30.162(1 3/16)	38.100(1 1/2)	15.88(.625)	2.8					15 000	22 500	12 000	—
30.162(1 3/16)	38.100(1 1/2)	25.40(1.000)	2.8	30.162	30.146	38.114	38.089	25 800	45 300	12 000	—
30.162(1 3/16)	38.100(1 1/2)	15.88(.625)	—					28 400	53 600	5 000	—

1N ≈ 0.102kgf

TA
TLA
BA
BHA



轴径31.750 - 33.338mm

轴径 mm (inch)	公称型号									
	标准型	质量 (参考) g	一端密闭型	质量 (参考) g	标准型	质量 (参考) g	一端密闭型	质量 (参考) g	润滑脂固定	质量 (参考) g
31.750 (1 1/4)	BA 208 Z	21.5	BAM 208	26	—	—	—	—	—	—
	BA 2010 Z	27	BAM 2010	31.5	—	—	—	—	—	—
	BA 2012 Z	32.5	BAM 2012	37	—	—	—	—	—	—
	BA 2016 Z	43	BAM 2016	47.5	—	—	—	—	—	—
	BA 2020 Z	53.5	BAM 2020	58	—	—	—	—	—	—
	—	—	—	—	—	—	—	—	YB 2010	35
	—	—	—	—	—	—	—	—	YB 2012	42.5
	—	—	—	—	—	—	—	—	YB 2016	57
	—	—	—	—	—	—	—	—	YB 2018	64
	—	—	—	—	—	—	—	—	YB 2020	68
33.338 (1 5/16)	—	—	—	—	BHA 208 Z	34.5	BHAM 208	40	—	—
	—	—	—	—	BHA 2012 Z	49.5	BHAM 2012	54.5	—	—
	—	—	—	—	BHA 2016 Z	66	BHAM 2016	71	—	—
	—	—	—	—	BHA 2020 Z	81.5	BHAM 2020	86.5	—	—
33.338 (1 5/16)	BA 218 Z	28.5	BAM 218	35	—	—	—	—	—	—
	BA 2110 Z	35.5	BAM 2110	41.5	—	—	—	—	—	—
	BA 2112 Z	43	BAM 2112	49	—	—	—	—	—	—

注(1) 容许转速适用于润滑油润滑。润滑脂润滑的话可容许到该值的60%。
备注 润滑脂固定满滚子冲压外圈型滚针轴承已封入润滑脂。标准型及一端密闭型未封入润滑脂，请适当润滑后使用。

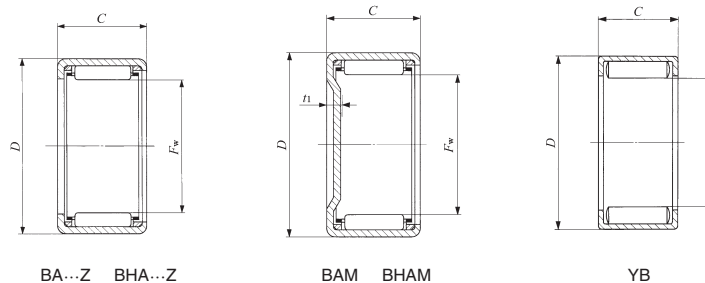

主要尺寸 mm(inch)			标准安装尺寸 mm				基本额定 动负荷 C	基本额定 静负荷 C0	容许(1) 转速 min ⁻¹	搭配的内圈					
F _w	D	C	t ₁ 最大	轴径 h6 最大 最小	轴承座直径 J7 最大 最小										
31.750(1 1/4)	38.100(1 1/2)	12.70(.500)	2.8	31.750	31.734	38.114	38.089	9 100	14 700	12 000	IRB 168				
31.750(1 1/4)	38.100(1 1/2)	15.88(.625)	2.8					12 500	22 200	12 000	IRB 1610				
31.750(1 1/4)	38.100(1 1/2)	19.05(.750)	2.8					15 700	29 600	12 000	IRB 1612				
31.750(1 1/4)	38.100(1 1/2)	25.40(1.000)	2.8					21 500	44 300	12 000	IRB 1616				
31.750(1 1/4)	38.100(1 1/2)	31.75(1.250)	2.8					26 900	59 200	12 000	IRB 1620				
31.750(1 1/4)	38.100(1 1/2)	15.88(.625)	—					27 000	59 000	4 500	IRB 1610				
31.750(1 1/4)	38.100(1 1/2)	19.05(.750)	—					31 800	72 500	4 500	IRB 1612				
31.750(1 1/4)	38.100(1 1/2)	25.40(1.000)	—					31.750	31.734	38.114	38.089	40 900	100 000	4 500	IRB 1616
31.750(1 1/4)	38.100(1 1/2)	28.58(1.125)	—					45 300	114 000	4 500	—				
31.750(1 1/4)	38.100(1 1/2)	31.75(1.250)	—					49 400	128 000	4 500	IRB 1620				
31.750(1 1/4)	41.275(1 5/8)	12.70(.500)	3.4	31.750	31.734	41.289	41.264	13 700	17 600	12 000	IRB 168				
31.750(1 1/4)	41.275(1 5/8)	19.05(.750)	3.4					24 100	36 400	12 000	IRB 1612				
31.750(1 1/4)	41.275(1 5/8)	25.40(1.000)	3.4					33 200	55 000	12 000	IRB 1616				
31.750(1 1/4)	41.275(1 5/8)	31.75(1.250)	3.4					40 000	69 600	12 000	IRB 1620				
33.338(1 5/16)	41.275(1 5/8)	12.70(.500)	2.8	33.338	33.322	41.289	41.264	11 100	15 800	11 000	IRB 168-1				
33.338(1 5/16)	41.275(1 5/8)	15.88(.625)	2.8					15 400	23 900	11 000	IRB 1610-1				
33.338(1 5/16)	41.275(1 5/8)	19.05(.750)	2.8					19 300	32 100	11 000	IRB 1612-1				

1N ≈ 0.102kgf

英制系列



轴径34.925 - 38.100mm

轴径 mm (inch)	公称型号									
	标准型	质量 (参考) g	一端密闭型	质量 (参考) g	标准型	质量 (参考) g	一端密闭型	质量 (参考) g	润滑脂固定	质量 (参考) g
34.925 (1 3/8)	BA 228 Z	23.5	BAM 228	29	—	—	—	—	—	—
	BA 2212 Z	35.5	BAM 2212	41	—	—	—	—	—	—
	BA 2216 Z	47.5	BAM 2216	53	—	—	—	—	—	—
	BA 2220 Z	59	BAM 2220	64	—	—	—	—	—	—
	—	—	—	—	—	—	—	—	YB 228	30.5
	—	—	—	—	—	—	—	—	YB 2212	46
	—	—	—	—	—	—	—	—	YB 2220	77.5
	—	—	—	—	BHA 228 Z	37	BHAM 228	43	—	—
	—	—	—	—	BHA 2210 Z	44	BHAM 2210	50	—	—
	—	—	—	—	BHA 2212 Z	53	BHAM 2212	59	—	—
—	—	—	—	BHA 2216 Z	71	BHAM 2216	77	—	—	
—	—	—	—	BHA 2220 Z	87	BHAM 2220	98.5	—	—	
38.100 (1 1/2)	BA 248 Z	38.5	BAM 248	47.5	—	—	—	—	—	—
	BA 2410 Z	48.5	BAM 2410	57.5	—	—	—	—	—	—
	BA 2412 Z	58.5	BAM 2412	67.5	—	—	—	—	—	—
	BA 2414 Z	69	BAM 2414	78	—	—	—	—	—	—
	BA 2416 Z	79	BAM 2416	88	—	—	—	—	—	—
	BA 2420 Z	97.5	BAM 2420	106	—	—	—	—	—	—
	—	—	—	—	—	—	—	—	YB 246	38
	—	—	—	—	—	—	—	—	YB 248	51.5
	—	—	—	—	—	—	—	—	YB 2414	91
	—	—	—	—	—	—	—	—	YB 2416	105
—	—	—	—	—	—	—	—	YB 2420	131	

注(1) 容许转速适用于润滑油润滑。润滑脂润滑的话可容许到该值的60%。

备注 润滑脂固定满滚子冲压外圈型滚针轴承已封入润滑脂。标准型及一端密闭型未封入润滑脂，请适当润滑后使用。

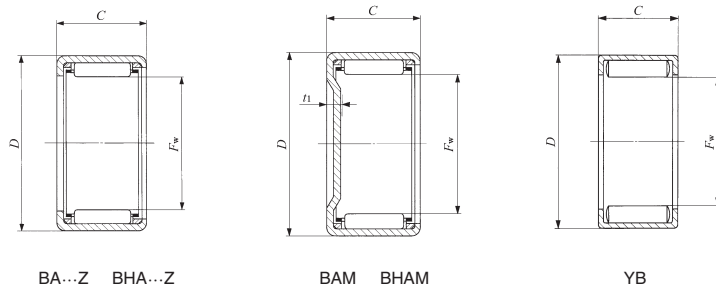

主要尺寸 mm(inch)				标准安装尺寸 mm				基本额定 动负荷 C	基本额定 静负荷 C ₀	容许 ⁽¹⁾ 转速 min ⁻¹	搭配的内圈
F _w	D	C	t ₁ 最大	轴径 h6		轴承座直径 J7					
				最大	最小	最大	最小	N	N		
34.925(1 3/8)	41.275(1 5/8)	12.70(.500)	2.8					9 770	16 600	10 000	IRB 188
34.925(1 3/8)	41.275(1 5/8)	19.05(.750)	2.8					16 900	33 500	10 000	IRB 1812
34.925(1 3/8)	41.275(1 5/8)	25.40(1.000)	2.8					23 100	50 200	10 000	IRB 1816
34.925(1 3/8)	41.275(1 5/8)	31.75(1.250)	2.8	34.925	34.909	41.289	41.264	28 900	67 100	10 000	IRB 1820
34.925(1 3/8)	41.275(1 5/8)	12.70(.500)	—					23 000	49 500	4 500	IRB 188
34.925(1 3/8)	41.275(1 5/8)	19.05(.750)	—					33 400	79 800	4 500	IRB 1812
34.925(1 3/8)	41.275(1 5/8)	31.75(1.250)	—					52 000	141 000	4 500	IRB 1820
34.925(1 3/8)	44.450(1 3/4)	12.70(.500)	3.4					14 100	18 800	10 000	IRB 188
34.925(1 3/8)	44.450(1 3/4)	15.88(.625)	3.4					19 700	28 800	10 000	—
34.925(1 3/8)	44.450(1 3/4)	19.05(.750)	3.4	34.925	34.909	44.464	44.439	24 800	38 800	10 000	IRB 1812
34.925(1 3/8)	44.450(1 3/4)	25.40(1.000)	3.4					34 100	58 400	10 000	IRB 1816
34.925(1 3/8)	44.450(1 3/4)	31.75(1.250)	3.4					41 200	74 200	10 000	IRB 1820
38.100(1 1/2)	47.625(1 7/8)	12.70(.500)	2.8					12 900	17 900	9 000	—
38.100(1 1/2)	47.625(1 7/8)	15.88(.625)	2.8					17 800	27 100	9 000	IRB 2010
38.100(1 1/2)	47.625(1 7/8)	19.05(.750)	2.8					22 500	36 600	9 000	—
38.100(1 1/2)	47.625(1 7/8)	22.22(.875)	2.8	38.100	38.084	47.639	47.614	26 700	45 600	9 000	IRB 2014
38.100(1 1/2)	47.625(1 7/8)	25.40(1.000)	2.8					31 100	55 400	9 000	IRB 2016
38.100(1 1/2)	47.625(1 7/8)	31.75(1.250)	2.8					39 000	74 200	9 000	IRB 2020
38.100(1 1/2)	47.625(1 7/8)	9.52(.375)	—					21 000	34 100	4 000	—
38.100(1 1/2)	47.625(1 7/8)	12.70(.500)	—					28 700	50 900	4 000	—
38.100(1 1/2)	47.625(1 7/8)	22.22(.875)	—	38.100	38.084	47.639	47.614	48 900	101 000	4 000	IRB 2014
38.100(1 1/2)	47.625(1 7/8)	25.40(1.000)	—					55 100	118 000	4 000	IRB 2016
38.100(1 1/2)	47.625(1 7/8)	31.75(1.250)	—					66 800	151 000	4 000	IRB 2020

1N ≈ 0.102kgf

英制系列

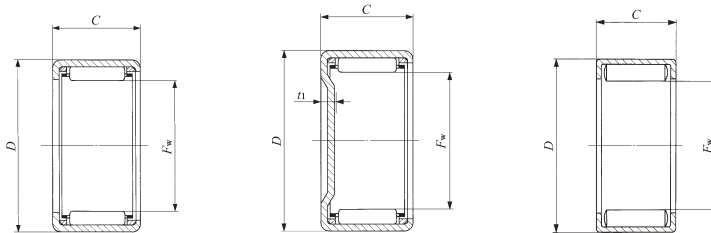

BA...Z BHA...Z

BAM BHAM

YB

轴径41.275 - 52.388mm

轴径 mm (inch)	公称型号										
	标准型	质量 (参考) g	一端密封型	质量 (参考) g	标准型	质量 (参考) g	一端密封型	质量 (参考) g	润滑脂固定	质量 (参考) g	
41.275 (1 ⁵ / ₈)	BA 268 Z	41	BAM 268	51.5	—	—	—	—	—	—	
	BA 2610 Z	52	BAM 2610	62.5	—	—	—	—	—	—	
	BA 2616 Z	85	BAM 2616	95.5	—	—	—	—	—	—	
	BA 2620 Z	105	BAM 2620	115	—	—	—	—	—	—	
	—	—	—	—	—	—	—	—	YB 2610	69	
44.450 (1 ³ / ₄)	BA 2812 Z	67.5	BAM 2812	79.5	—	—	—	—	—	—	
	BA 2816 Z	91	BAM 2816	103	—	—	—	—	—	—	
	BA 2820 Z	112	BAM 2820	125	—	—	—	—	—	—	
	BA 2824 Z	136	BAM 2824	148	—	—	—	—	—	—	
	—	—	—	—	BHA 2824 Z	195	BHAM 2824	210	—	—	YB 2816
47.625 (1 ⁷ / ₈)	BA 308 Z	47.5	BAM 308	61	—	—	—	—	—	—	
	BA 3010 Z	60	BAM 3010	74	—	—	—	—	—	—	
	BA 3012 Z	72.5	BAM 3012	86.5	—	—	—	—	—	—	
	BA 3016 Z	97.5	BAM 3016	112	—	—	—	—	—	—	
	—	—	—	—	—	—	—	—	YB 3012	95	
50.800 (2)	BA 328 Z	50	BAM 328	66	—	—	—	—	—	—	
	BA 3216 Z	104	BAM 3216	119	—	—	—	—	—	—	
	BA 3220 Z	128	BAM 3220	144	—	—	—	—	—	—	
	BA 3224 Z	155	BAM 3224	170	—	—	—	—	—	—	
	BAW3228Z	180	BAMW3228	196	—	—	—	—	—	—	
—	—	—	—	—	—	—	—	YB 3216	130		
52.388 (2 ¹ / ₁₆)	—	—	—	—	BHA 3312 Z	104	BHAM 3312	122	—	—	
	—	—	—	—	BHA 3316 Z	139	BHAM 3316	157	—	—	
	—	—	—	—	BHA 3324 Z	205	BHAM 3324	225	—	—	

注(1) 容许转速适用于润滑油润滑。润滑脂润滑的话可容许到该值的60%。

备注1. 公称型号中的“W”表示滚动体为双列。

2. 润滑脂固定满滚子冲压外圈型滚针轴承已封入润滑脂。标准型及一端密封型未封入润滑脂，请适当润滑后使用。

主要尺寸 mm(inch)				标准安装尺寸 mm				基本额定 动负荷 C	基本额定 静负荷 C ₀	容 许 ⁽¹⁾ 转 速	搭配的内圈
F _w	D	C	t ₁ 最大	轴径 h6		轴承座直径 J7					
				最大	最小	最大	最小	N	N	min ⁻¹	
41.275(1 ⁵ / ₈)	50.800(2)	12.70(.500)	2.8					13 700	19 800	8 000	—
41.275(1 ⁵ / ₈)	50.800(2)	15.88(.625)	2.8					18 900	30 000	8 000	IRB 2210
41.275(1 ⁵ / ₈)	50.800(2)	25.40(1.000)	2.8	41.275	41.259	50.818	50.788	33 000	61 400	8 000	—
41.275(1 ⁵ / ₈)	50.800(2)	31.75(1.250)	2.8					41 400	82 100	8 000	IRB 2220
41.275(1 ⁵ / ₈)	50.800(2)	15.88(.625)	—					37 000	71 700	3 500	IRB 2210
44.450(1 ³ / ₄)	53.975(2 ¹ / ₈)	19.05(.750)	2.8					25 200	44 500	7 500	IRB 2412
44.450(1 ³ / ₄)	53.975(2 ¹ / ₈)	25.40(1.000)	2.8					34 800	67 400	7 500	IRB 2416
44.450(1 ³ / ₄)	53.975(2 ¹ / ₈)	31.75(1.250)	2.8	44.450	44.434	53.993	53.963	43 600	90 200	7 500	—
44.450(1 ³ / ₄)	53.975(2 ¹ / ₈)	38.10(1.500)	2.8					52 000	113 000	7 500	IRB 2424
44.450(1 ³ / ₄)	53.975(2 ¹ / ₈)	25.40(1.000)	—					59 500	136 000	3 500	IRB 2416
44.450(1 ³ / ₄)	57.150(2 ¹ / ₄)	38.10(1.500)	3.4	44.450	44.434	57.168	57.138	72 200	135 000	7 500	IRB 2424
47.625(1 ⁷ / ₈)	57.150(2 ¹ / ₄)	12.70(.500)	2.8					14 700	22 800	7 000	IRB 248-1
47.625(1 ⁷ / ₈)	57.150(2 ¹ / ₄)	15.88(.625)	2.8					20 300	34 500	7 000	IRB 2410-1
47.625(1 ⁷ / ₈)	57.150(2 ¹ / ₄)	19.05(.750)	2.8	47.625	47.609	57.168	57.138	25 700	46 700	7 000	—
47.625(1 ⁷ / ₈)	57.150(2 ¹ / ₄)	25.40(1.000)	2.8					35 400	70 600	7 000	—
47.625(1 ⁷ / ₈)	57.150(2 ¹ / ₄)	19.05(.750)	—					47 800	105 000	3 000	—
50.800(2)	60.325(2 ³ / ₈)	12.70(.500)	2.8					15 400	24 700	6 000	—
50.800(2)	60.325(2 ³ / ₈)	25.40(1.000)	2.8					37 100	76 500	6 000	IRB 2616
50.800(2)	60.325(2 ³ / ₈)	31.75(1.250)	2.8	50.800	50.781	60.343	60.313	46 600	102 000	6 000	IRB 2720
50.800(2)	60.325(2 ³ / ₈)	38.10(1.500)	2.8					55 500	128 000	6 000	—
50.800(2)	60.325(2 ³ / ₈)	44.45(1.750)	2.8					57 900	136 000	6 000	IRB 2628
50.800(2)	60.325(2 ³ / ₈)	25.40(1.000)	—					64 100	156 000	2 500	IRB 2616
52.388(2 ¹ / ₁₆)	64.294(2 ¹ / ₁₆)	19.05(.750)	3.4					36 400	62 100	6 000	—
52.388(2 ¹ / ₁₆)	64.294(2 ¹ / ₁₆)	25.40(1.000)	3.4	52.388	52.369	64.312	64.282	50 600	94 700	6 000	—
52.388(2 ¹ / ₁₆)	64.294(2 ¹ / ₁₆)	38.10(1.500)	3.4					73 900	154 000	6 000	—

1N ≈ 0.102kgf

英制系列

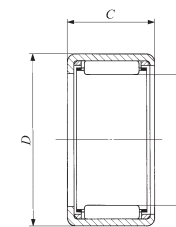

BA...Z

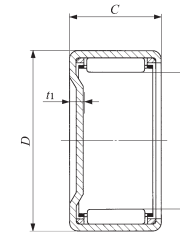

BAM

轴径53.975 – 69.850mm

轴径 mm (inch)	公称型号									
	标准型	质量 (参考) g	一端密闭型	质量 (参考) g	标准型	质量 (参考) g	一端密闭型	质量 (参考) g	润滑脂固定	质量 (参考) g
53.975 (2 ¹ / ₈)	BA 348 Z	53	BAM 348	70.5	—	—	—	—	—	—
	BA 3416 Z	109	BAM 3416	127	—	—	—	—	—	—
	BA 3424 Z	162	BAM 3424	180	—	—	—	—	—	—
57.150 (2 ¹ / ₄)	BA 3612 Z	85.5	BAM 3612	105	—	—	—	—	—	—
	BA 3616 Z	115	BAM 3616	135	—	—	—	—	—	—
	BA 3620 Z	143	BAM 3620	163	—	—	—	—	—	—
	BA 3624 Z	172	BAM 3624	192	—	—	—	—	—	—
66.675 (2 ⁵ / ₈)	BA 4216 Z	133	BAM 4216	161	—	—	—	—	—	—
69.850 (2 ³ / ₄)	BA 4410 Z	85.5	BAM 4410	115	—	—	—	—	—	—
	BA 4412 Z	103	BAM 4412	133	—	—	—	—	—	—
	BA 4416 Z	139	BAM 4416	169	—	—	—	—	—	—
	BA 4420 Z	173	BAM 4420	205	—	—	—	—	—	—

主要尺寸 mm(inch)				标准安装尺寸 mm				基本额定 动负荷 C	基本额定 静负荷 C ₀	容 许 ⁽¹⁾ 转 速	搭配的内圈
F _w	D	C	t ₁ 最大	轴径 h6		轴承座直径 J7					
53.975(2 ¹ / ₈)	63.500(2 ¹ / ₂)	12.70(.500)	2.8	最大	最小	最大	最小	16 100	26 600	5 500	—
53.975(2 ¹ / ₈)	63.500(2 ¹ / ₂)	25.40(1.000)	2.8	53.975	53.956	63.518	63.488	38 700	82 500	5 500	IRB 3016
53.975(2 ¹ / ₈)	63.500(2 ¹ / ₂)	38.10(1.500)	2.8					57 900	138 000	5 500	IRB 3024
57.150(2 ¹ / ₄)	66.675(2 ⁵ / ₈)	19.05(.750)	2.8					28 500	56 700	5 000	—
57.150(2 ¹ / ₄)	66.675(2 ⁵ / ₈)	25.40(1.000)	2.8	57.150	57.131	66.693	66.663	39 300	85 700	5 000	—
57.150(2 ¹ / ₄)	66.675(2 ⁵ / ₈)	31.75(1.250)	2.8					49 400	115 000	5 000	—
57.150(2 ¹ / ₄)	66.675(2 ⁵ / ₈)	38.10(1.500)	2.8					58 800	144 000	5 000	—
66.675(2 ⁵ / ₈)	76.200(3)	25.40(1.000)	2.8	66.675	66.656	76.218	76.188	42 000	97 900	4 000	IRB 3616
69.850(2 ³ / ₄)	79.375(3 ¹ / ₈)	15.88(.625)	2.8					25 000	50 800	3 500	—
69.850(2 ³ / ₄)	79.375(3 ¹ / ₈)	19.05(.750)	2.8	69.850	69.831	79.393	79.363	31 500	68 700	3 500	—
69.850(2 ³ / ₄)	79.375(3 ¹ / ₈)	25.40(1.000)	2.8					43 500	104 000	3 500	IRB 4016
69.850(2 ³ / ₄)	79.375(3 ¹ / ₈)	31.75(1.250)	2.8					54 600	139 000	3 500	IRB 4020

注(1) 容许转速适用于润滑油润滑。润滑脂润滑的话可容许到该值的60%。
备注 润滑脂固定满滚子冲压外圈型滚针轴承已封入润滑脂。标准型及一端密闭型未封入润滑脂，请适当润滑后使用。

1N ≈ 0.102kgf

TA
TLA
BA
BHA

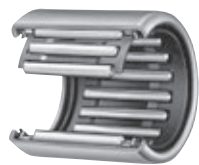

轴径12 - 50mm

轴径 mm	公称型号	质量 (参考) g	主要尺寸 mm			标准安装尺寸 mm			
			F_w	D	C	轴径 h6		轴承座直径 N7	
						最大	最小	最大	最小
12	TLA 1216 UU	11.7	12	18	16	12.000	11.989	17.995	17.977
14	TLA 1416 UU	13.3	14	20	16	14.000	13.989	19.993	19.972
15	TLA 1516 UU	14	15	21	16	15.000	14.989	20.993	20.972
16	TLA 1616 UU	14.8	16	22	16	16.000	15.989	21.993	21.972
18	TLA 1816 UU	16.3	18	24	16	18.000	17.989	23.993	23.972
20	TLA 2016 UU	17.8	20	26	16	20.000	19.987	25.993	25.972
	TLA 2020 UU	22.5	20	26	20				
22	TLA 2216 UU	19.4	22	28	16	22.000	21.987	27.993	27.972
	TLA 2220 UU	25	22	28	20				
25	TLA 2516 UU	26	25	32	16	25.000	24.987	31.992	31.967
	TLA 2520 UU	33	25	32	20				
28	TLA 2820 UU	36.5	28	35	20	28.000	27.987	34.992	34.967
30	TLA 3016 UU	30.5	30	37	16	30.000	29.987	36.992	36.967
	TLA 3020 UU	39	30	37	20				
35	TLA 3516 UU	35	35	42	16	35.000	34.984	41.992	41.967
	TLA 3520 UU	45	35	42	20				
40	TLA 4016 UU	39.5	40	47	16	40.000	39.984	46.992	46.967
	TLA 4020 UU	50.5	40	47	20				
45	TLA 4520 UU	56	45	52	20	45.000	44.984	51.991	51.961
50	TLA 5026 UU	89	50	58	26	50.000	49.984	57.991	57.961

注(1) 容许转速适用于润滑脂润滑。
备注 两侧密封型已封入润滑脂。

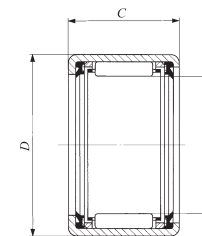

TLA...UU

基本额定动 负荷 C	基本额定静 负荷 C_0	容许 ⁽¹⁾ 转 速
N	N	min ⁻¹
6 420	7 490	14 000
7 080	8 840	12 000
7 380	9 520	11 000
7 670	10 200	11 000
8 230	11 500	9 000
8 740	12 900	9 000
11 100	17 500	9 000
9 230	14 300	8 000
11 700	19 300	8 000
9 440	13 900	7 000
12 800	20 500	7 000
13 800	23 500	6 000
10 400	16 600	5 500
14 100	24 500	5 500
11 600	20 000	5 000
15 700	29 600	5 000
12 400	22 800	4 500
16 700	33 700	4 500
17 800	37 800	4 000
28 800	64 100	3 500

1N ≈ 0.102kgf